

# Calibration

External calibration can be performed with an external calibration weight equal to the scale's capacity.

1. Enter the Weighing Mode by pressing the Function key. Select "T" by pressing the T key.

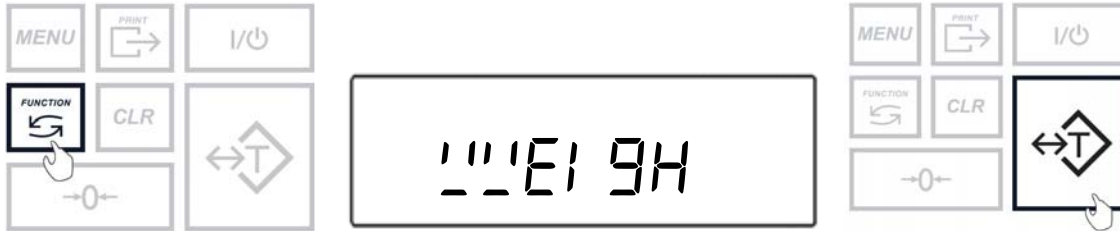

2. Use a flathead screwdriver to gently remove the Calibration Seal Screw located in the rear of the scale.

3. Once the screw has been removed and the calibration switch exposed, use a pen or another pointing device to toggle the calibration switch to the right (which is the ON position).

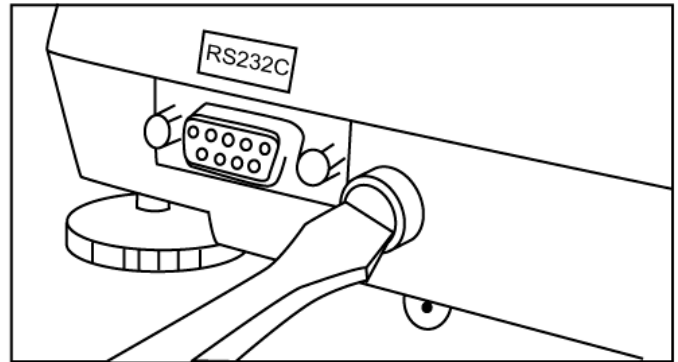

4. Upon toggling of the calibration switch, the balance will go into Calibration Mode.

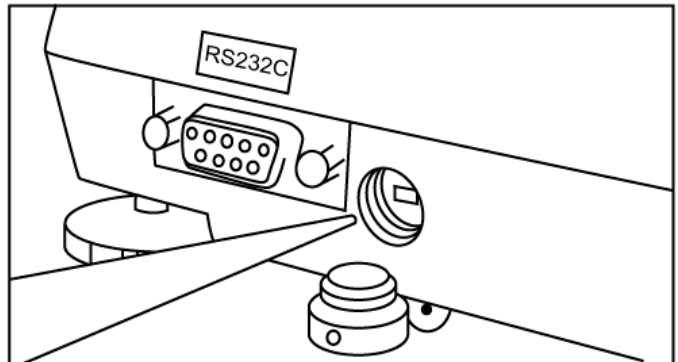
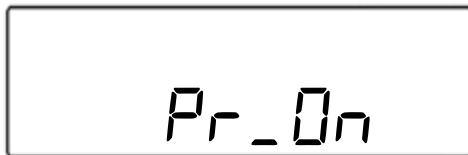

5. To start calibration, press the Menu key.

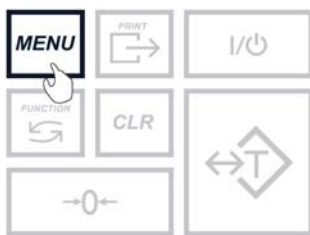

6. Select "Cal On" by pressing T key.

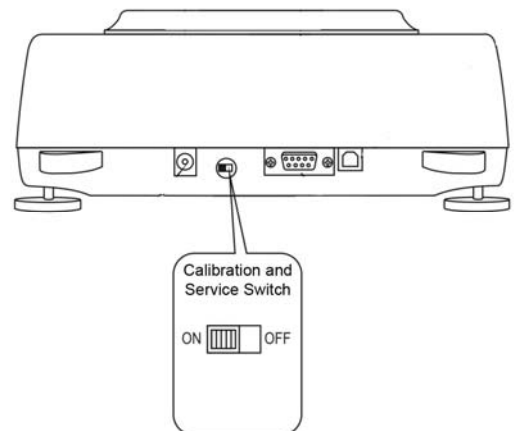
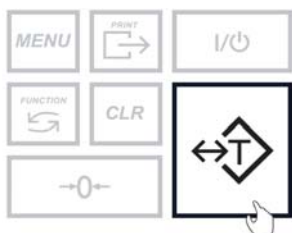

7. Wait for the scale to tare.

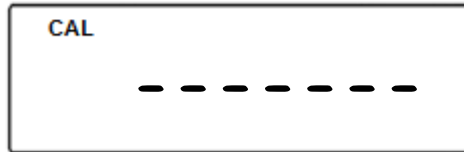

8. When prompted, load a calibration weight equal to the weight displayed on the screen. (Calibration weight varies by model).

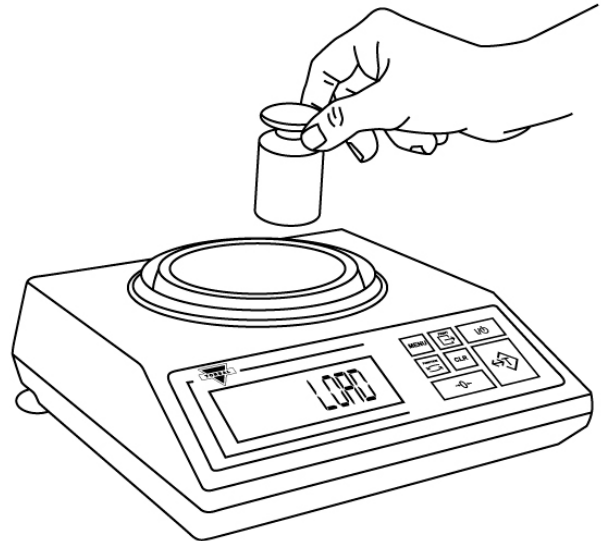

9. Wait for the scale to calibrate.

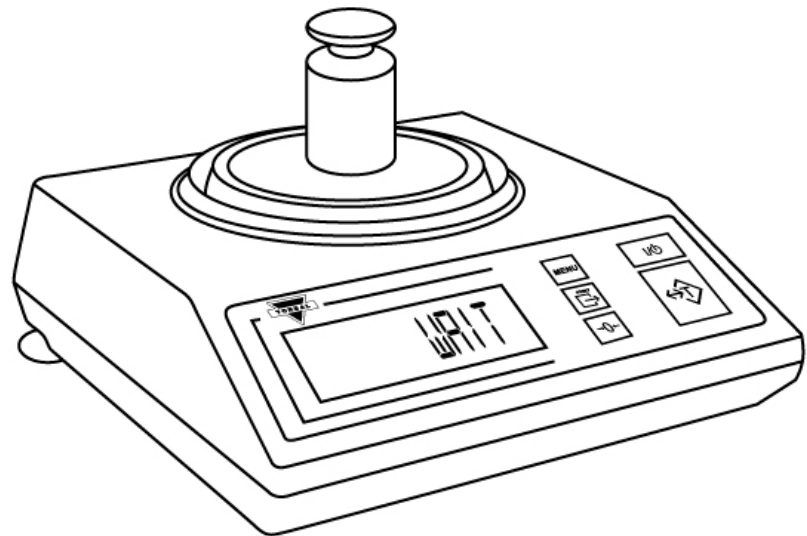

10. When calibration has ended the scale will display Pr\_On. Toggle the calibration switch in the rear of the scale back to its original position.

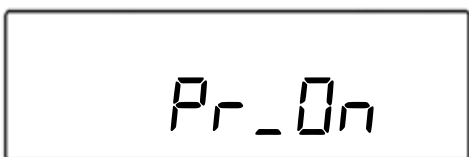

11. Insert the Calibration Seal Screw back into place.