

## Table of Contents

Chapter 1: Cautionary Notes and Warnings .....	1
Chapter 2: Specifications .....	4
Chapter 3: Parts Description .....	5
Chapter 4: Keys, Display Indicators and Commands .....	6
Chapter 5: Modes and Function Descriptions.....	7
Chapter 6: Unpacking the torque Gauge and Getting Started.....	9
Chapter 7: Taking Measurements and Saving Results .....	10
Chapter 8: Main Menu .....	14
Chapter 9: Applications and Modes.....	15
9.1 Standard Mode .....	15
9.2 Peak Mode .....	17
9.3 Multi Peak Mode .....	20
9.4 Fill Meter.....	22
Chapter 10: Data Manager – Retrieving and Managing Saved Data.....	24
10.1 Retrieving and Managing Saved Data .....	25
10.2 Custom data file name format.....	26
10.3 Formatting the SD card .....	27
Chapter 11: Measurement Settings.....	28
11.1 Record and Speed .....	28
11.2 Units – Selecting Default Unit of Measure .....	30
11.3 Auto Zeroing .....	31
11.4 Threshold – Output Port and Internal Buzzer .....	32
11.5 Direction – Reversing Compression and Tension .....	33
Chapter 12: Configuration .....	34
12.1 Printout.....	35
12.2 Interface(USB, RS232, wireless).....	36
12.3 LCD Settings .....	37
12.4 Time & Date.....	38
12.5 Keypad-Disabling and Enabling Buzzer Feedback.....	39
12.6 Auto-Off – Power Save Settings.....	39
12.7 Battery- Disabling Charging .....	40
12.8 External Input- Remote Trigger .....	41
12.9 Firmware Update.....	42
12.10 Defaults.....	43
Chapter 13: Calibration.....	44
13.1 Calibrating with Mass or torque .....	44
13.2 Setting Gravitational Acceleration Value.....	47
13.3 Using Geographical Location Coordinates .....	47
13.4 Setting a Correction Value .....	48
13.5 Setting Load Cell Sensitivity mV/V (Use when interchanging load-cells) .....	49
13.6 Restoring Factory Calibration .....	49
13.7 Calibration PIN Access.....	50
Chapter 14: Torque Guage Info .....	51
Chapter 15: Connecting to PC - Communication Protocol.....	52
15.1 torque Gauge Communication Protocol.....	54
Chapter 16: Wireless PC Connection .....	55
Chapter 17: Input/Output Port Configuration .....	59
Chapter 18: Common Errors and Troubleshooting.....	60
Chapter 19: Maintenance .....	61
Chapter 20: Technical Information, Measurement, and Dimensions .....	62
Chapter 21: Limited Warranty .....	64

## Chapter 1: Cautionary Notes and Warnings

### Important Handling Cautions and Warnings

Always handle your torque gauge with care.

Damage caused by improper handling is not covered under warranty.



**DO NOT** let the torque gauge fall or drop onto the ground!



**DO NOT** pass or handle liquids near the torque gauge to prevent spillage and liquid damage!

**Always** align the torque gauge shaft to the object measured, to prevent the shaft from warping and damaging the device!



**DO NOT** attempt to measure the torque of an object that is submerged in a liquid

**Never** use the torque gauge if there is an object or material wedged between the measuring rod and frame!

**Cautionary Notes and Precautions**

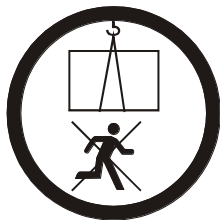

**Never stand under a torque gauge in use. Equipment may fall or collapse, causing breakage and possible injury.**

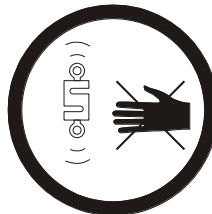

**Keep safe distance from the load cell. Always use safety gloves, safety glasses and other protective gear.**

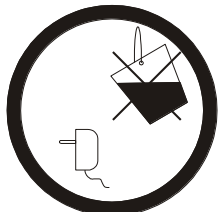

**Always keep the torque gauge and the power supply from water or other liquids.**

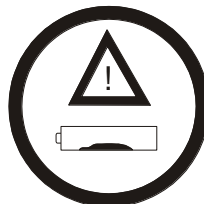

**Damaged batteries must be handled with extra care. Use rubber gloves and safety glasses. Dispose only in designated recycling centers.**

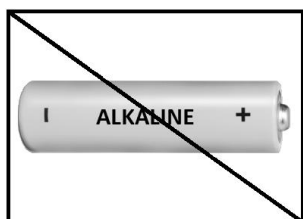

**Always disable charging before installing disposable batteries. Charging non-rechargeable, alkaline batteries can be hazardous and cause damage to the torque gauge.**

**CAUTION:**



- The torque gauge is designed for indoor use only.
- Do not operate the torque gauge in hazardous areas or under dangerous conditions.
- Do not use the torque gauge in locations subject to high humidity or dust.
- Do not connect cables in ways other than those mentioned in this manual.
- Never stand on or lean on this product. Equipment may fall or collapse, causing breakage and possible injury.
- Before moving the product, unplug it and unplug all cables connected to it.
- When storing, transporting or returning the torque gauge for service, always use the original packaging.

**WARNING:**



- Never attempt to repair, disassemble or modify the torque gauge. Tampering with the torque gauge may result in injury and cause greater damage to the equipment.
- Be sure to use the specified power source.
- Do not allow foreign matter to fall onto the torque gauge.
- If water or other liquid spills onto the torque gauge, unplug the power cord immediately and contact technical support.



- Disposal of electronic equipment in waste containers is forbidden by law.

## Important Mounting and Installation Cautions



- Torque Gauge Capacity must always exceed the predicted measurement load.
- Elements or parts used in mounting that are not supplied with the torque gauge, such attachments attachments, convertors, adapters, or bolt, must withstand torque of no less than 150% of torque gauge capacity.

### Warning!

**Custom attachment, adapters, or mounting bolts and other connection hardware or elements not supplied with the torque gauge must sustain loads of at least 150% of torque gauge capacity. Any bolt or nut must be precisely matched to the diameter of loadcell socket or opening.**



# Chapter 2: Specifications

	Model		
	FSA2	FSA5	FSA10
Capacity	17lbf.in   0.2kgf.m   2Nm	44lbf.in   0.5kgf.m   5Nm	100lbf.in   1kgf.m   10Nm
Resolution	0.01lbf.in   0.1gf.m   0.001Nm	0.01lbf.in   0.1gf.m   0.001Nm	0.1lbf.in   1gf.m   0.01Nm
Sampling rate	1000Hz		
Accuracy	± 0.5% Full Scale		
Overload	150% Full Scale (Display Limit: 110%)		
Interface	BT Wireless, USB (B Type), RS232, microSD (SDHC Class 4)		
Input / Output Port	YES		
Operating Temperature	14°F to 104°F   -10 to 40°C   Humidity: Up to 80 % Max.		
Measuring Units	Nm, N.cm, kgf.m, gf.m, lbf.in		
Power Supply	12V, 1.2A,		
Rechargeable Batteries	4 x Ni-MH 2700mAh, 1.2V		
Battery Operating Time	14h (LCD Backlight OFF, BT Wireless OFF)   11h (LCD Backlight ON, BT Wireless OFF)   8h (LCD Backlight ON, BT Wireless ON)		
Sample Diameter Range	0.79in to 7.09in (20mm to 180mm)		
Dimensions	13.6in x 9.3in x 6.3in (345mm x 236mm x 160mm)		
Unit Weight	11.3lb (5.1kg)		

# Chapter 3: Parts Description

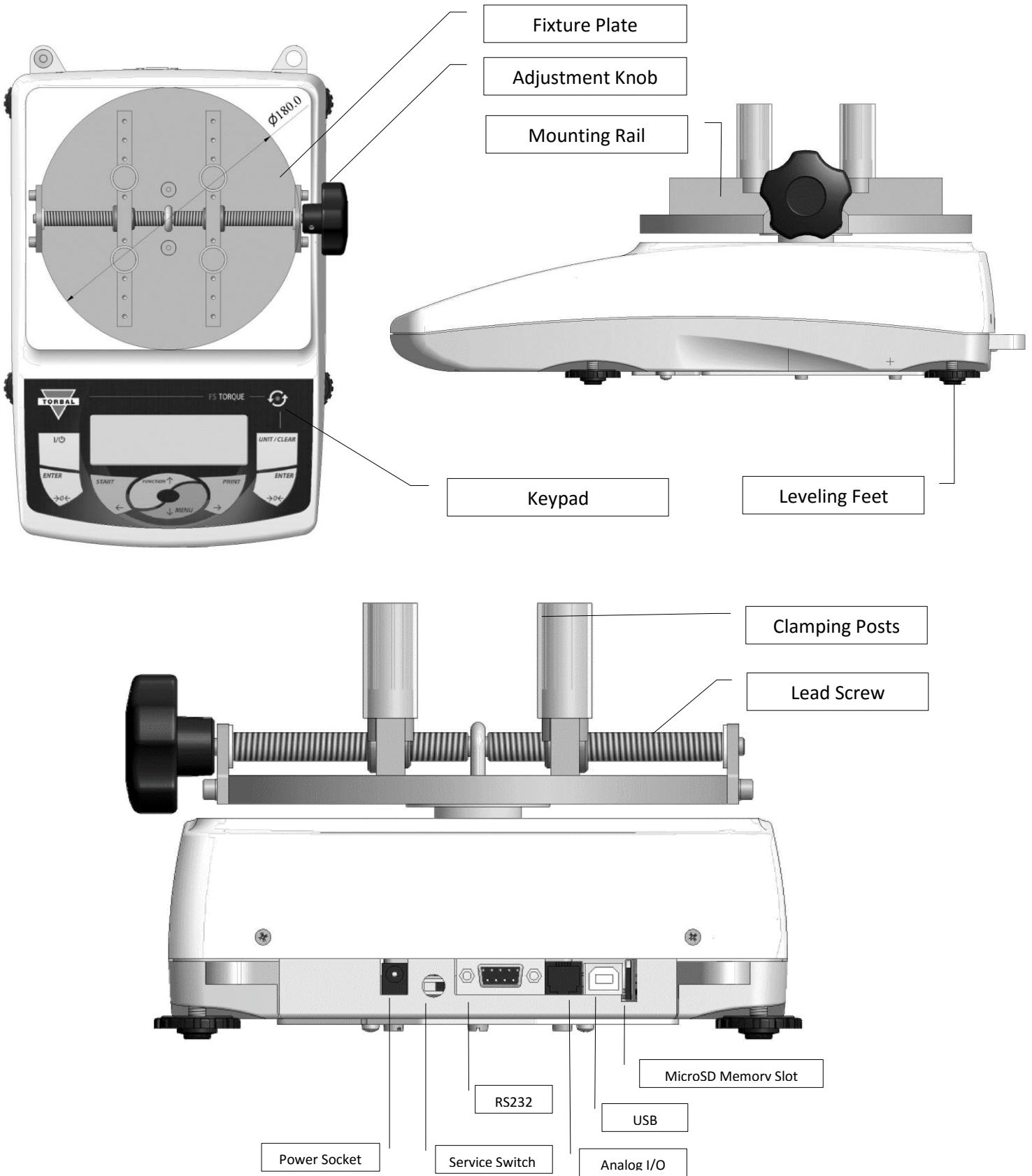



# Chapter 4: Keys, Display Indicators and Commands

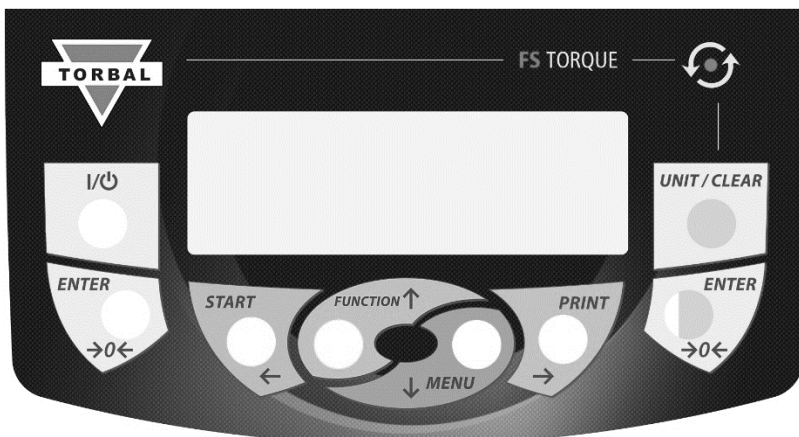

Key	Primary Function	Secondary Function
ON / OFF	Turn the unit ON	Turn the unit OFF
UNIT / CLEAR	Toggle between available units of measure. Exit menu folder	Press once to pause measuring sequence. Press and hold to reset measuring sequence before time is reached.
BACKLIGHT	Turn the backlight on	
FUNCTION	Toggle between enabled application modes	Navigation key UP. Press and hold to access Statistical Analysis at any time
START	Start measuring sequence or capture measurement	Navigation key Left.
PRINT	Initiate print or data transfer via RS232 or USB	Navigation key Right
MENU	Access the Main Menu. Press once to access Menu options	Navigation key down. In Peak Mode press and hold to toggle between Tension, Compression, Tension & Compression
ENTER	Zero the torque Gauge	Accept and confirm commands
Display Indicator	Description	
OFF	Power Off	The torque gauge is turned OFF and in standby mode.
AUT	Auto-Zero Setting	Auto zeroing enabled and the torque gauge maintains a "center of zero" condition within.
SDH	MicroSD Card	The MicroSD Card is inserted and functional
MAN	Manual	Standard or Peak Modes are set to Manual
LOCK	Result Lock	Result is locked on the screen until cleared.
PK	Peak	Peak Mode enabled
ACQ	Acquiring	torque Gauge is acquiring measurements
TRG	Trigger	Trigger value has not been reached
DELAY	Delay	Delay in progress
MIN	Minimum	Indicates that the minimum threshold limit has been reached
MAX	Maximum	Indicates that the maximum threshold limit has been reached
OK	Target	Indicates that the target threshold limit has been reached
	Stability Indicator	The result has stabilized and reading may be taken.
	Wireless	Wireless data transmitter is enabled
	Battery	Battery Charging Status

## Chapter 5: Modes and Function Description

### Standard Mode [Menu>Applications>Standard Mode]

The standard mode offer utmost flexibility when using the torque gauge manually, in a test stand, or while connected to a PC. torque measurements can be captured manually with a press of the start button or automatically over a specified time frame. The mode is equipped with Time Delay, Trigger, and Threshold features.

---

### Peak Mode [Menu>Applications>Peak Mode]

The peak mode automatically detects the maximum torque measured during a test. The feature pinpoints the exact torque applied to an object before it gives or breaks under pressure. The application can be configured to detect torque automatically or manually.

---

### Multi-Peak Mode [Menu>Applications>Multi Peak]

The Multi-Peak mode records multiple peaks detected during a user specified time frame. The feature detects unlimited number of peaks in a measured sequence. The Multi-Peak mode is particularly useful when measuring torque of objects that do not instantly give or break under pressure, such as fabrics or flexible materials.

---

### Fill Meter [Menu>Applications>Fill Meter]

Filling meter indicator can be activated in conjunction with any mode of the torque gauge. The fill meter is a digital non-linear pie meter which has greatly increased sensitivity at the set capacity cutoff point. The feature allows to set a custom cut off point that is suitable to the application. This feature helps to avoid exceeding the maximum capacity of the torque by providing visual feedback while taking measurements.

---

### Programmable Thresholds Monitoring [Menu>Applications>Mode>Threshold]

Programmable threshold limits are available in all torque gauge modes. The feature allows to set minimum, maximum, and target values that are monitored by the torque gauge. When exceeded the displays MIN, MAX, and OK indicators are on the display. Each indicator can be set to sound a single or a continuous alarm. Threshold values are also used to determine if the torque applied during tests can produce consistent results that stays within the set parameters.

---

### Peak Detection / Peak Sensitivity [Menu>Applications>Peak Mode>Peak Detec.]

Peak and Multi-Peak modes are equipped with a sensitivity detection feature which allows to disregard unwanted peak measurements that may be caused by shakes or vibration. The peak sensitivity detection feature allows peak detection modes to be fine-tuned to a specific application.

---

### Data Manager [Menu>Data Manager]

The data manager feature allows to quickly review and retrieve saved measurements. The feature organizes data into function folders with chronological .txt file names. File names can be assigned with a unique alphanumeric names or identifier, which are automatically organized chronologically.

---



---

**Auto-Save / Automatic Data Storing [Menu>Data Manager>Auto-Save]**

Auto-save automatically saves results and statistical analysis of the measurements to the MicroSD card. When enabled the torque gauge will save results at the end of each measurements. Each result set is assigned with unique file name.

---

**Record & Speed / Configurable Sampling Speed [Menu>Measur. Settings>Record & Speed]**

The gauge can be set to measure torque at a desired speed. A slower rate makes it easier for the torque measurements to be seen on the display in real-time. A faster measuring speed allows for a more accurate test as the torque gauge can capture more results in a shorter time sequence, and samples are taken more frequently.

---

**Printout / Configurable Receipt Printing [Menu>Configuration>Printout]**

The torque gauge can send results directly to a printer as well as third party software such as MS excel or notepad. The printed information can be configured to include the date, time, measurement name, user ID, signature line, and a series of customizable notes.

---

**External Input / Output and Input Modes [Menu>Configuration>External Input]**

The threshold output mode enables the Output port by sending voltage level signals which can be used for signaling or controlling external peripherals that can connect with the torque gauge. The output mode can be used in combination with Programmable Thresholds Monitoring. Input mode allows an external button or a pedal to be used as trigger for starting torque measurements and taking samples. OUTPUT Ampacity: I max=25mA / U nom=24V (open collector type, emitters connected– GND) | INPUT Voltage Range IN (+)/IN (-): U in=12-18V / I in max=50Ma

---

## Chapter 6: Unpacking the torque Gauge and Getting Started

1. Carefully take the torque gauge out of the box.



2. Use the supplied hex key to firmly connect the fixture plate to the loadcell.

3. Install the clamping posts on the mounting rail by inserting them into the rail openings. Space the posts accordingly to diameter of the measured container.

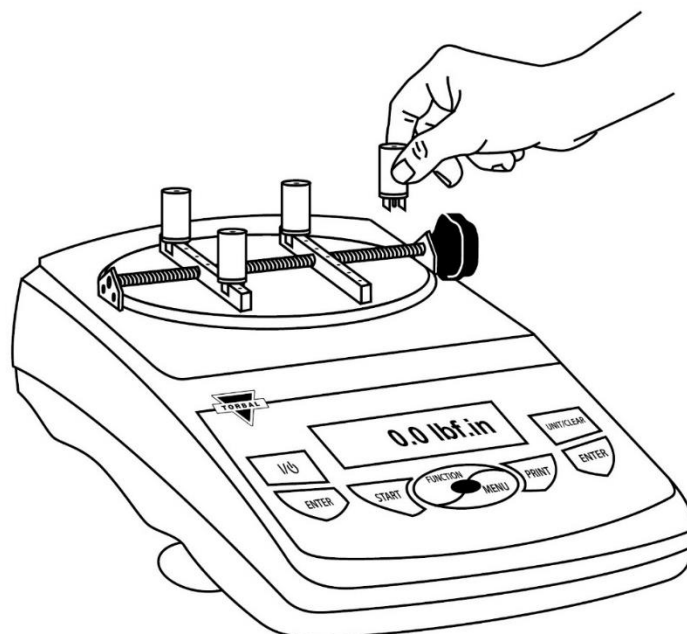

4. Connect the torque gauge to a power outlet by plugging the AC adapter into the 12V socket at the bottom of the unit. Once the AC adapter is connected to the torque gauge, plug the other end into a wall socket.

# Chapter 7: Taking Measurements and Saving Results

1. Press the *ON/OFF* key to turn the torque gauge ON.

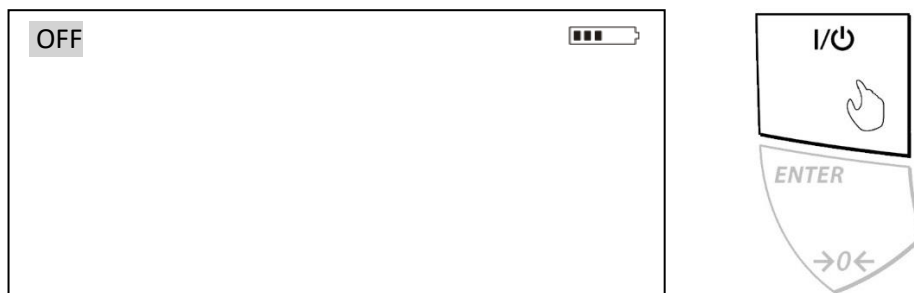

2. Do not move or attempt to use the torque gauge as it is initializing. The torque gauge will power on in the last mode it was turned off.
3. Once the torque gauge is turned on, it is ready to use.

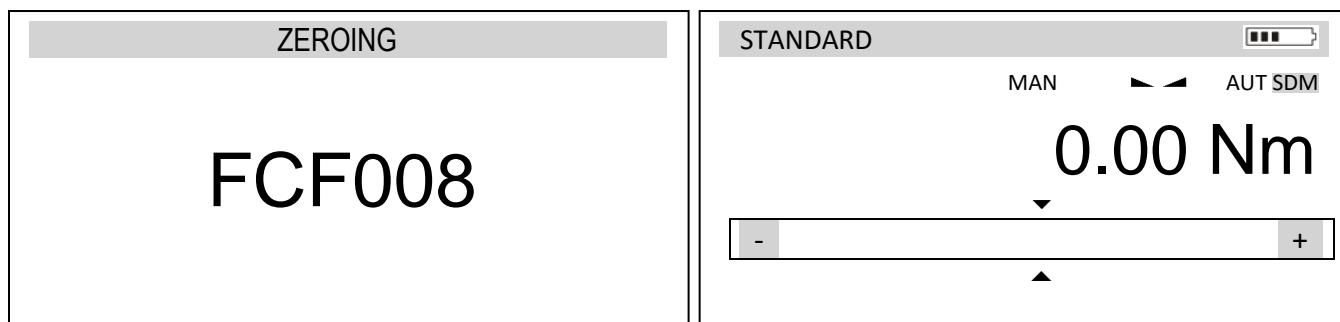

4. To select or change a mode press the Function key until a desired mode is highlighted. Only enabled modes are available for selection.

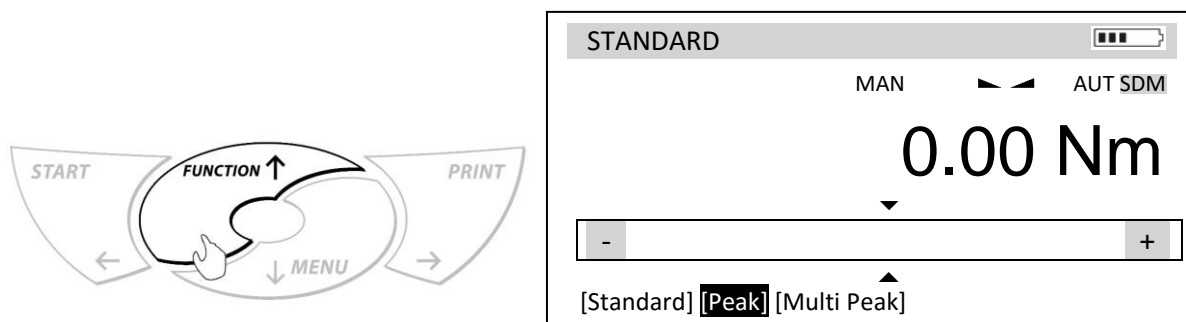

- To select or change a unit of measure press the Unit / Clear button until a desired unit of measure is highlighted.

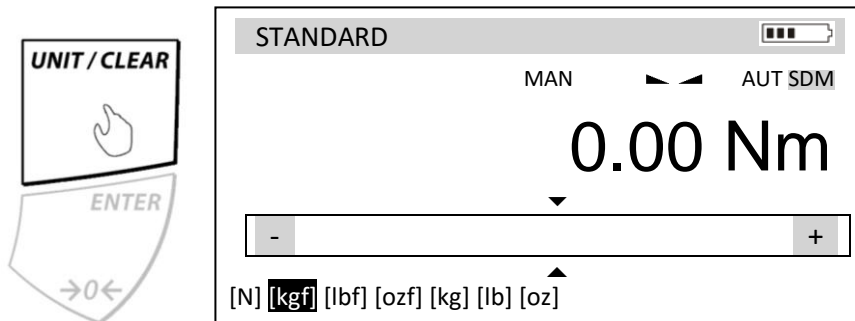

- Install the container or jar by placing it on the mounting rails. Adjust the clamping posts accordingly to the diameter of the container or jar. Turn the adjustment knob in the clockwise direction until the container is firmly secured in the fixture plate.
- Before taking a measurement zero the torque gauge by pressing the  $\rightarrow 0 \leftarrow$  / ENTER key.

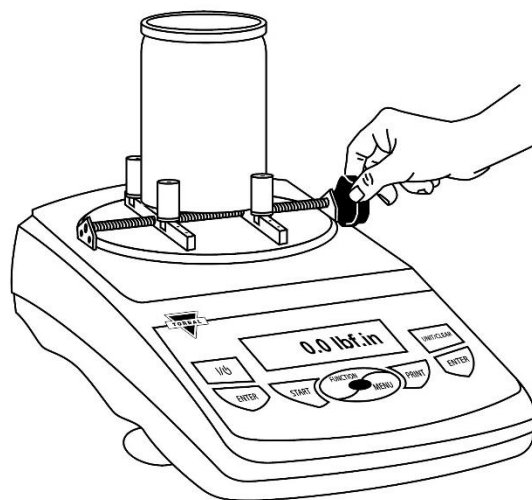
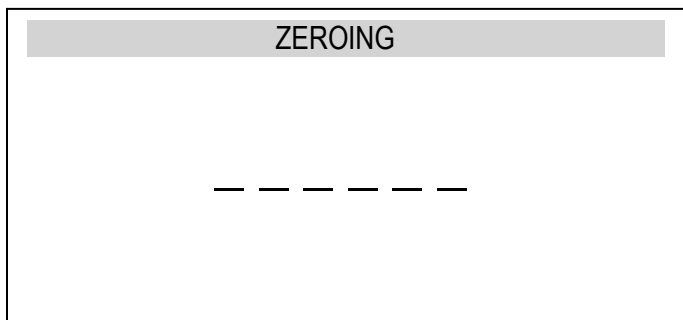
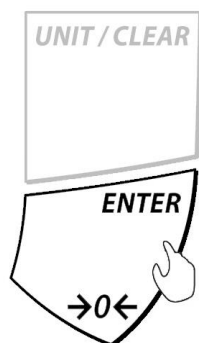
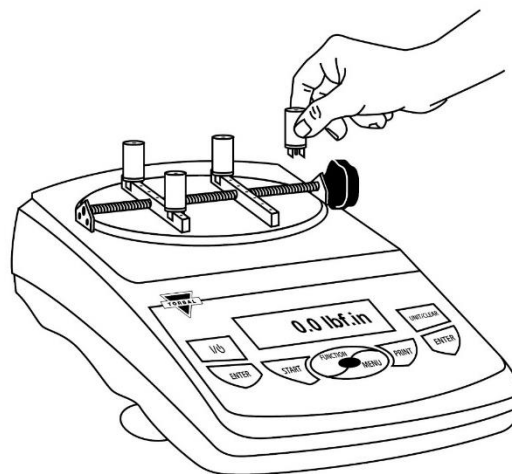

8. To measure torque of an object turn the container cap in the clockwise or counterclockwise direction. Observe the measurements recorded as the torque is applied.

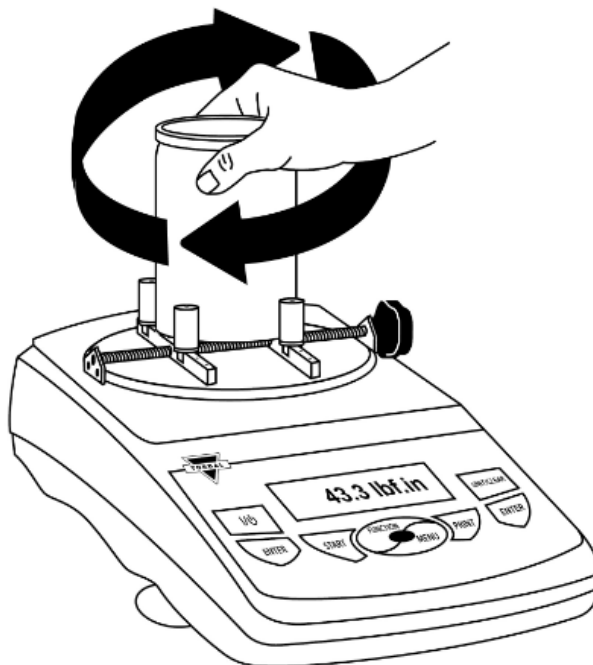

9. Depending on the configuration and mode in use, measurements are captured automatically or with a press of the START key.

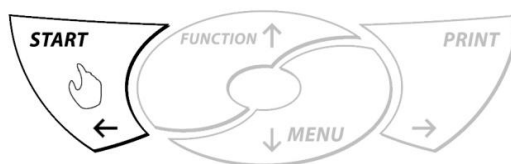

10. To pause measurements, press the Unit / Clear key once. To clear and rest the measurement at any time press and hold the Unit / Clear key.

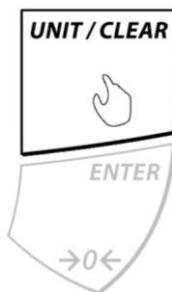



11. Once the measurement time has expired, or all required samples have been captured, the torque gauge will conduct a statistical analysis which is automatically displayed on the screen. Use the arrow keys to select and view the chart and histogram. To clear data and start new measurement select EXIT.

**PEAK MODE STATUS**

Status:	Successful
Samples:	10
Total:	+ 17.10 N
Average:	+ 5.70 N
MAX:	+ 7.25 N
MIN:	+ 4.80 N
MAX-MIN:	+ 2.45 N
St. dev:	1.65 N
Rel. dev:	23.65 %

**Save** Exit Chart Histo

**HISTOGRAM**

MIN MAX

< L01 = 1 >

PEA00001: + 7.25 N

**RESET DATA**

Please confirm:

NO  
**YES**

12. To save the result to your MicroSD card select SAVE and press the enter key. To save data to a new file select <set file name> or chose a previously saved file to overwrite data.

**CHOOSE FILE**

**<set file name>**

DATA001.TXT  
 DATA002.TXT  
 DATA003.TXT  
 DATA004.TXT  
 DATA005.TXT  
 DATA006.TXT

## Chapter 8: Main Menu

The *Main Menu* is used to configure the torque gauge and its measuring modes. There are nine options within the Main Menu:

1. To access the USER MENU, press the *MENU* key.

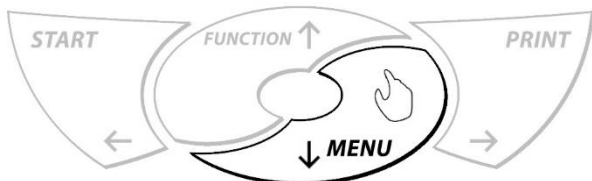

**USER MENU**

- 1. Applications**
2. Data Manager
3. Measur. Settings
4. Configuration
5. Calibration
6. Info
7. Exit

2. Use the arrow keys to scroll through the options and press ENTER to select one. *EXIT* will always return to the previous screen or menu folder.

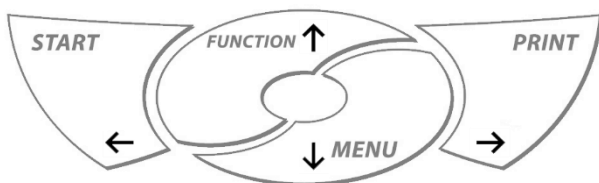

**USER MENU**

1. Applications
2. Data Manager
3. Measur. Settings
4. Configuration
5. Calibration
6. Info
- 7. Exit**



# Chapter 9: Applications and Modes

- To enable and configure the application modes press the Menu key to enter the Main Menu. Use the navigation keys to select Applications and press the Enter key.

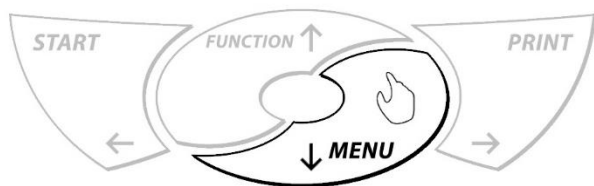

**USER MENU**

1. Applications
2. Data Manager
3. Measur. Settings
4. Configuration
5. Calibration
6. Info
7. Exit

## 9.1 Standard Mode

- To configure the Standard Mode use the navigation keys to select “Standard Mode” in “Applications” folder and press ENTER.

**APPLICATIONS**

1. Standard Mode
2. Peak Mode
3. Multi Peak
4. Fill Meter
5. Exit



- The status and available options will be displayed. If the function is currently in use the status will be set to “Enabled”. Use the arrow keys to navigate through the features and configure the mode.

**STANDARD MODE**

1. Status: <Enabled> <Disabled>
2. Mode: <Auto> <Manual>
3. Delay <Trigger> <Start>
4. Trigger: 0.00N
5. Del. Time: 0.0s
6. Meas. Time: 60.0s | Quantity: 10
7. Threshold: <ON> <OFF>
8. Min: 0.00N
9. Target: 0.00N
10. Max: 0.00N
11. Exit

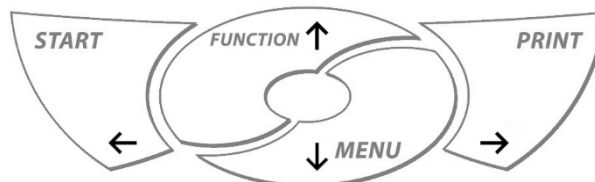



### Standard Mode Configuration Features

Feature	Options	Description and Functionality
Status	<Enable, Disable>	Enables and Disables the standard mode from the function menu. When disabled feature is not available for selection while pressing the function key.
Mode	<Auto, Manual>	<b>Manual:</b> Measurements are captured with the press of the start key. Measurement sequence is based on the quantity parameter set in the Quantity field. <b>Auto:</b> Measurements are automatically captured over specified period which is based on the measurement time parameters. Pressing the start key initiates the measurement cycle. The feature utilizes Delay and Trigger settings.
Delay	<Start, Trigger>	<b>Start:</b> torque trigger is disabled. The measurement sequence initiates after press of the Start key. Measurement sequence begins once the Delay Time value is reached. <b>Trigger:</b> Both Trigger and Delay Time values must be reached before measurement sequence begins.
Trigger	custom value	The amount of torque that needs to be reached before the measurement sequence begins. (Auto only)
Del. Time	custom value	The time that must be reached before the measurement sequence begins. (Auto only)
Quantity	custom value	Number of measurements that must be captured to end the measurement cycle. (Manual Only)
Meas. Time	custom value	Total time of the measurement sequence in the automatic mode.
Threshold	<On, Off>	Enables and disables measurement threshold monitoring.
Min	custom value	Minimum threshold value. When reached, MIN is displayed.
Target	custom value	Target threshold value when reached OK, is displayed.
Max	custom value	Maximum threshold value. When reached, and exceeded MAX is displayed
Exit		Exits the Applications settings folder.

- To measure torque of an object turn the container cap in the clockwise or counterclockwise direction. Observe the measurements recorded as the torque is applied.

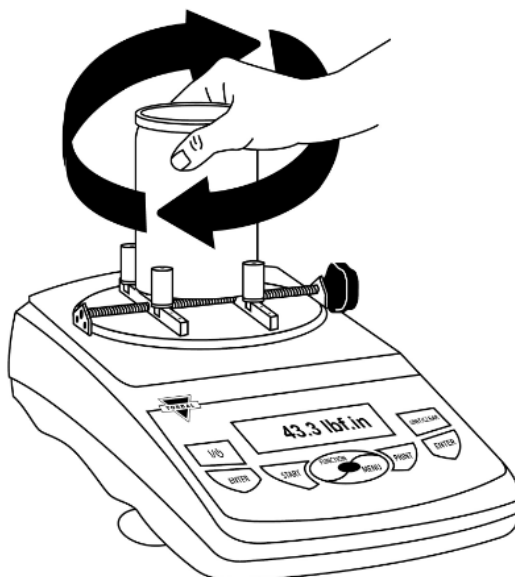



- Use the START key to begin acquiring torque measurements in the Automatic mode or to capture single measurement in the manual mode.

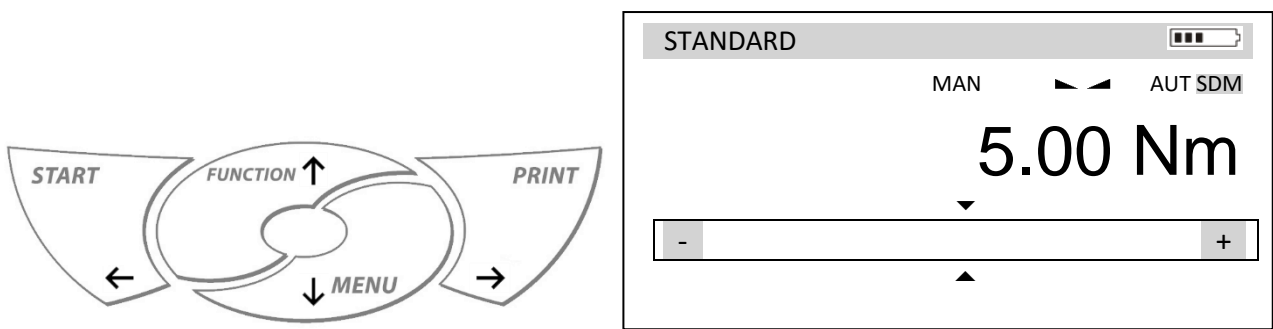

- Once the measurement time is reached (Automatic), or all required samples have been captured (Manual), the torque gauge will conduct a statistical analysis which is automatically displayed on the screen.

## 9.2 Peak Mode

- To configure the Peak Mode use the navigation keys to select "Peak Mode" in "Applications" folder and press ENTER.

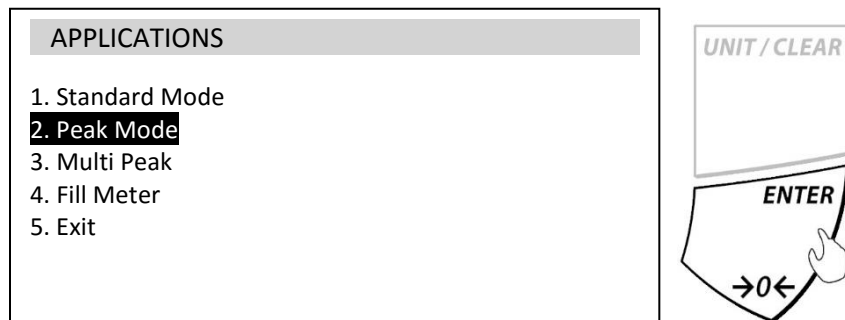

- The status and available options will be displayed. If the function is currently in use the status will be set to "Enabled". Use the arrow keys to navigate through the features and configure the mode.

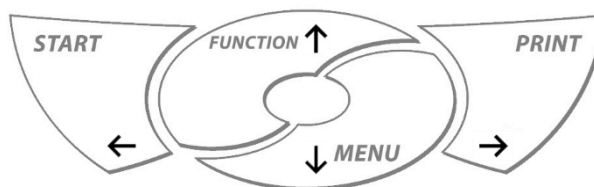
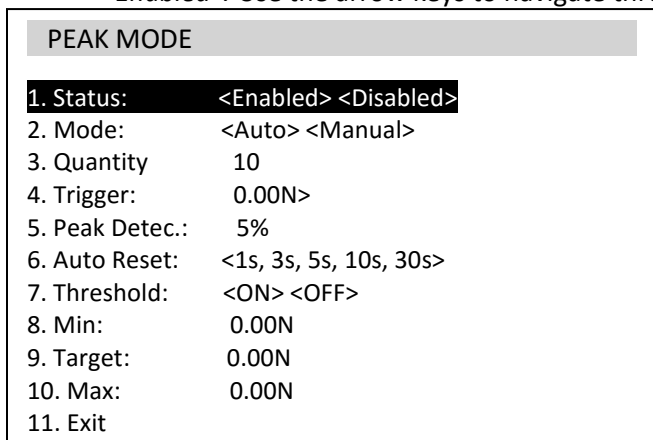



### Peak Mode Configuration Features

Feature	Options	Description and Functionality
Status	<Enable, Disable>	Enables and Disables the Peak mode from the function menu. When disabled feature is not available for selection while pressing the function key.
Mode	<Auto, Manual>	<b>Manual:</b> Peak torque is automatically detected and displayed on the torque Gauge. START key must be pressed to store the display peak value. The torque gauge must be manually zeroed before next measurement by pressing the →0← ENTER key. Measurement sequence is based on the quantity parameter set in the Quantity field. Trigger value must be reached before peak torque is detected. Peak torques below the trigger value are disregarded. <b>Auto:</b> The peak torque is automatically detected and displayed on the torque Gauge. The result is automatically stored. The torque Gauge is automatically zeroed before the next measurement. Auto utilizes peak detection and auto reset parameters.
Quantity:	custom value	Number of measurements that must be captured to end the measurement cycle.
Trigger	custom value	The amount of torque that needs to be reached before the measurement sequence begins.
Peak Detec.	custom value	Allows to disregard unwanted peaks and sets peak sensitivity detection. Peak values are stored only if the detected peak is followed by a set percentage drop defined by the Peak Detection parameter.
Auto Reset	<1s, 3s, 5s, 10s, 30s>	The time the peak value is displayed on the screen before automatically zeroing.
Threshold	<On, Off>	Enables and disables measurement threshold monitoring.
Min	custom value	Minimum threshold value. When reached, MIN is displayed.
Target	custom value	Target threshold value when reached OK is displayed.
Max	custom value	Maximum threshold value. When reached, and exceeded MAX is displayed.
Exit		Exits the Applications settings folder.



- To measure torque of an object turn the container cap in the clockwise or counterclockwise direction. Observe the measurements recorded as the torque is applied.

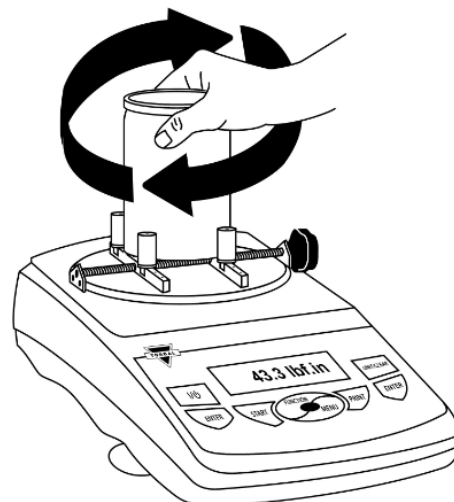

- The peak of the torque will be automatically detected and displayed on the torque gauge. If set to automatic, the peak will be automatically captured and the torque gauge will automatically zero for the next reading. If set to the Manual mode, press the START key to capture the detected peak which is displayed on the torque gauge. Prior to taking the next reading zero the gauge by pressing the →0← ENTER key. To switch between Compression and Tension press and hold the Menu key. To print the result or send it to a PC, press the Print key.

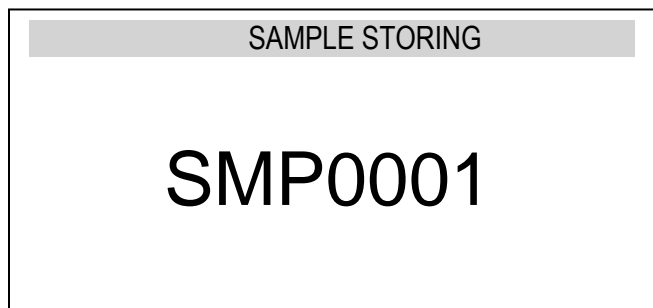
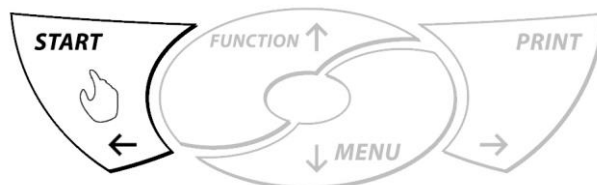
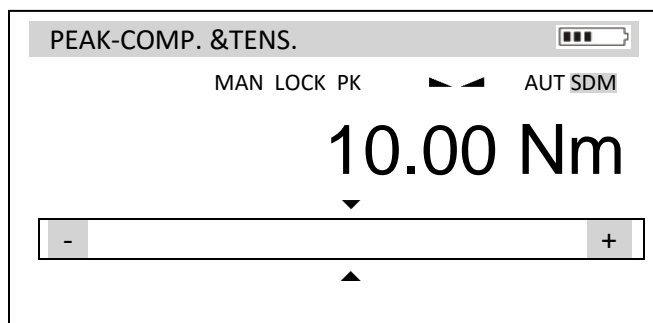

- Once the required samples have been captured, the torque gauge will conduct a statistical analysis which is automatically displayed on the screen.

### 9.3 Multi-Peak Mode

- To configure the Multi-Peak Mode use, the navigation keys to select “Multi Peak” in “Applications” folder and press ENTER.

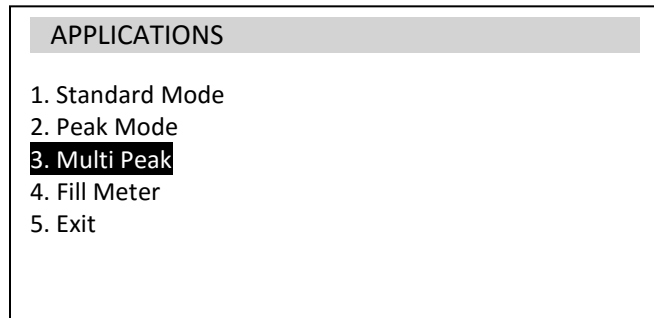

- The status and available options will be displayed. If the function is currently in use the status will be set to “Enabled”. Use the arrow keys to navigate through the features and configure the mode.

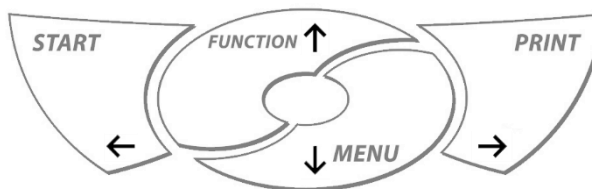
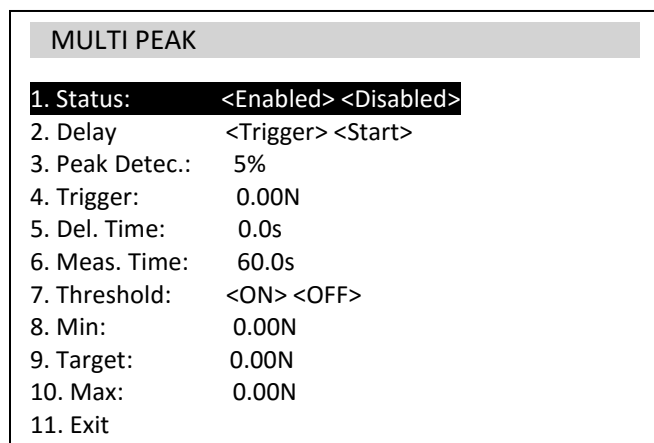

### Multi Peak Mode Configuration Features

Feature	Options	Description and Functionality
Status	<Enable, Disable>	Enables and Disables the Multi Peak mode from the function menu. When disabled feature is not available for selection while pressing the function key.
Delay	<Start, Trigger>	<b>Start:</b> torque trigger is disabled. The measurement sequence initiates after press of the Start key. Measurement sequence begins once the Delay Time value is reached. <b>Trigger:</b> Both Trigger and Delay Time values must be reached before measurement sequence begins.
Peak Detec.	custom value	Allows to disregard unwanted peaks and sets peak sensitivity detection. Peak values are stored only if the detected peak is followed by a set percentage drop defined by the Peak Detection parameter.
Trigger	custom value	The amount of torque that needs to be reached before the measurement sequence begins.
Del. Time	custom value	The time that must be reached before the measurement sequence begins.
Meas. Time	custom value	Total time of the measurement sequence.
Threshold	<On, Off>	Enables and disables measurement threshold monitoring.
Min	custom value	Minimum threshold value. When reached, MIN is displayed.
Target	custom value	Target threshold value when reached OK is displayed.
Max	custom value	Maximum threshold value. When reached, and exceeded MAX is displayed.
Exit		Exits the Applications settings folder.

- To measure torque of an object turn the container cap in the clockwise or counterclockwise direction. Observe the measurements recorded as the torque is applied.

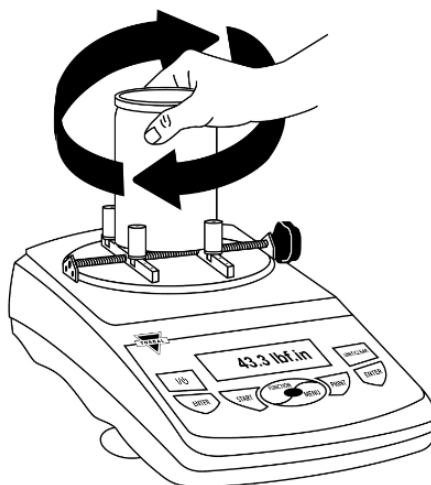

- Use the START key to begin acquiring torque measurements.

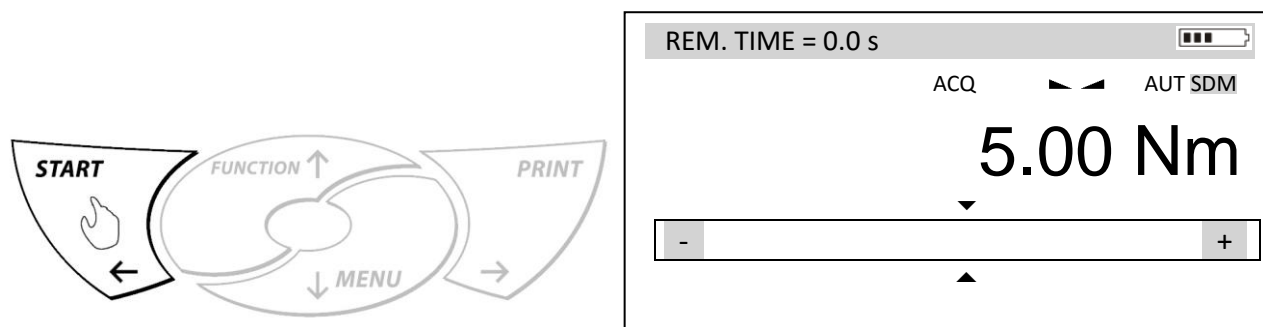

- Once the measurement time is reached, the torque gauge will conduct a statistical analysis which is automatically displayed on the screen.

### 9.4 Fill Meter

- To enable the Fill Meter use the navigation keys to select Fill Meter in Applications folder and press ENTER.

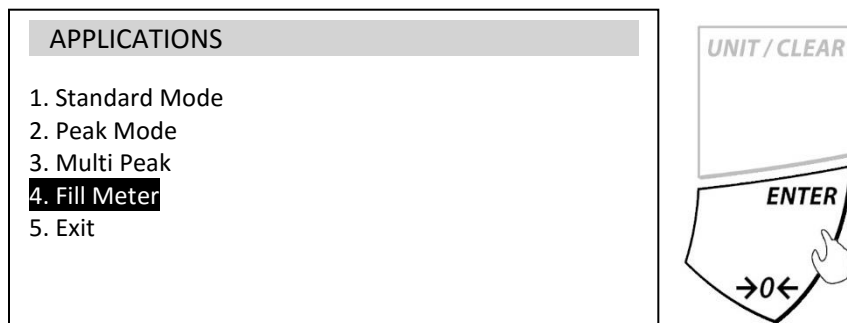

- Use the navigation keys to select Status press the Enter key and change the status to Enabled.

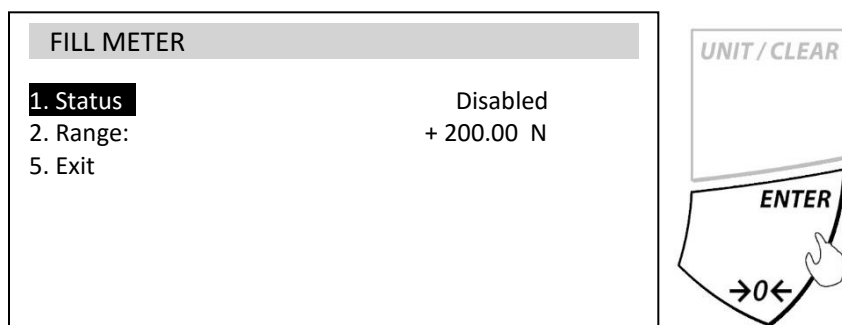

- Use the navigation keys to select Range and press the Enter key to change the range value of the Fill Meter. The range value defines the full scale of the Fill Meter. When enabled the Fill Meter is visible in all application modes.

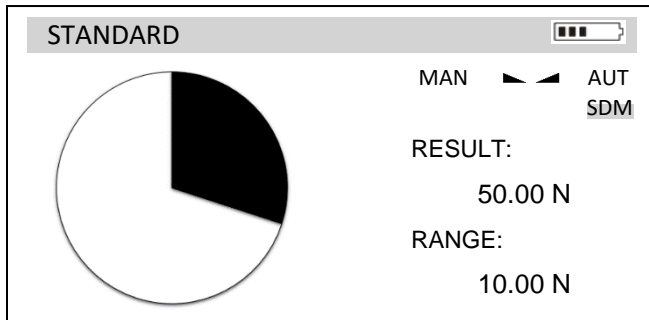



# Chapter 10: Data Manager - Retrieving and Managing Saved Data

Data Manager allows to view and manage saved data, enables automatic saving of measurement data, as well as file format configuration and SD card formatting.

1. To access Data Manager, press the Menu key and access the Main Menu. Use the navigation keys to select Data Manager and press the Enter key

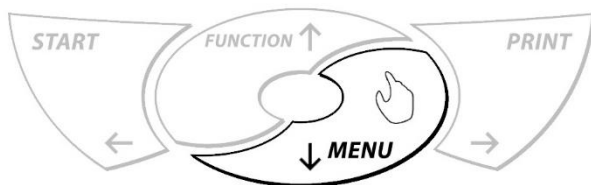

**USER MENU**

1. Applications
- 2. Data Manager**
3. Measur. Settings
4. Configuration
5. Calibration
6. Info
7. Exit

2. Use the arrow keys to navigate through the features and configure the function.

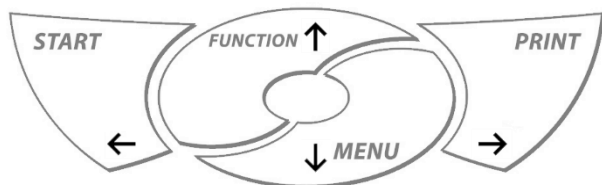

**DATA MANAGER**

- 1. View/Manage Saved**
2. Auto-Save: <Off, On>
3. SD Card
4. SD Format
5. Exit

### Data Manager Configuration Features

Feature	Options	Description and Functionality
Auto-Save	<Off, On>	Results are automatically saved at the end of each measurement sequence.
SD Card	-	Allows to define custom folder and file name. Which is used when saving data to the SD card.
SD Format	-	Formats and deletes all data stored on the SD card.



## 10.1 Retrieving and Managing Saved Data

- To view and manage saved data, select View/ Managed Saved from the Data Manager Menu and press the Enter key.

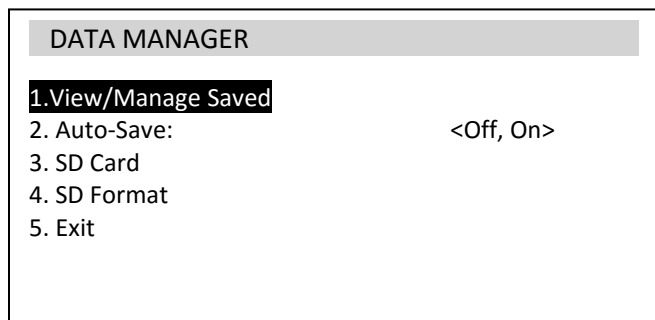

- Data is sorted into corresponding applications Mode. Use the navigation keys to select the mode and view saved data.

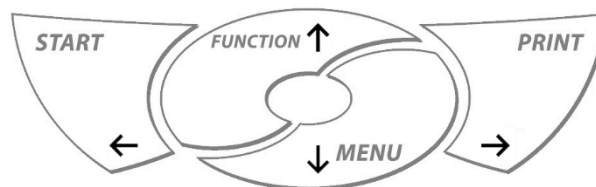
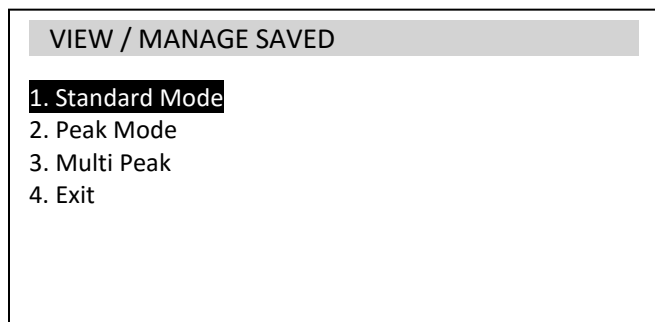

- Use the navigation keys to select a saved data file and press the Enter key. Select Load to view the file or permanently delete the file from the SD card.

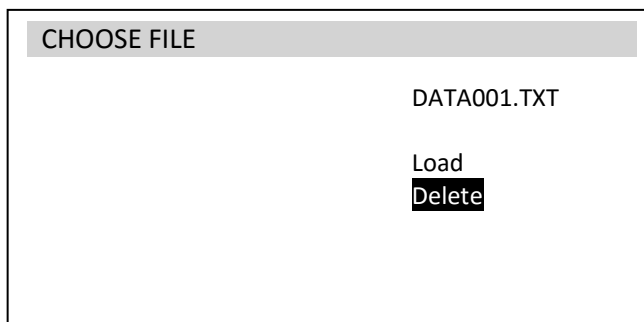
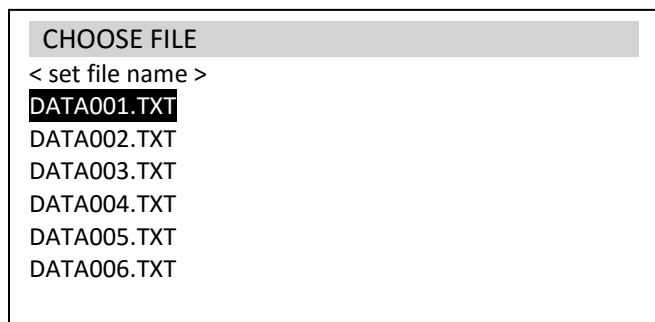

- Statistical analysis will be automatically displayed on the screen. Use the arrow keys to select and view the chart and histogram.

PEAK MODE STATUS			
Status:		Successful	
Samples:		10	
Total:	+	17.10 N	
Average:	+	5.70 N	
MAX:	+	7.25 N	
MIN:	+	4.80 N	
MAX-MIN:	+	2.45 N	
St. dev:		1.65 N	
Rel. dev:		23.65 %	
<b>Del.</b>	Exit	Chart	Histo

## 10.2 Custom data file name format

- To customize the data file name format, select SD Card from the Data Manager menu and press the Enter key.

DATA MANAGER	
1. View/Manage Saved	
2. Auto-Save:	<Off, On>
<b>3. SD Card</b>	
4. SD Format	
5. Exit	

- To assign a custom name of the folder for saving measurement results, select Folder and press the Enter key. Use the navigation keys to key in the folder name. The folder name cannot exceed 7 characters. Press Enter to confirm. The folder name will be created on the SD card.

SD CARD	
1. Folder:	FC_DATA
2. File:	DATA001.TXT
5. Exit	

- To assign custom file name for each measurement set, select File and press the Enter key. Use the navigation keys to key in the file name. The file name cannot exceed 7 characters. The last three characters must be numeric. Press Enter to confirm. Each file name automatically increments the last numeric value.

### 10.3 Formatting the SD card

1. To format and delete stored data on your micro SD card, select SD Format from the Data Manager menu and press the Enter key.

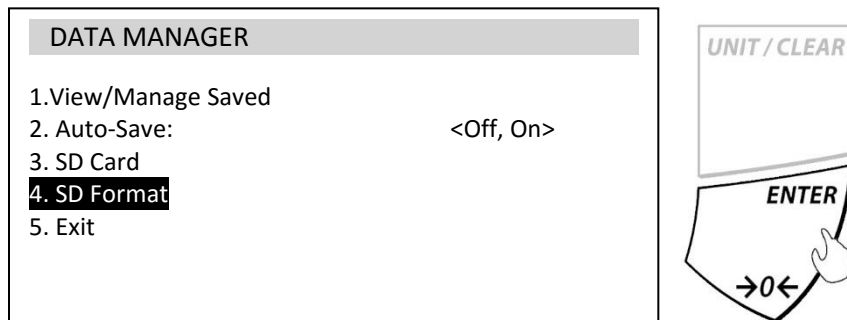

2. Select OK to format the SD card. Warning: All Records will be deleted!

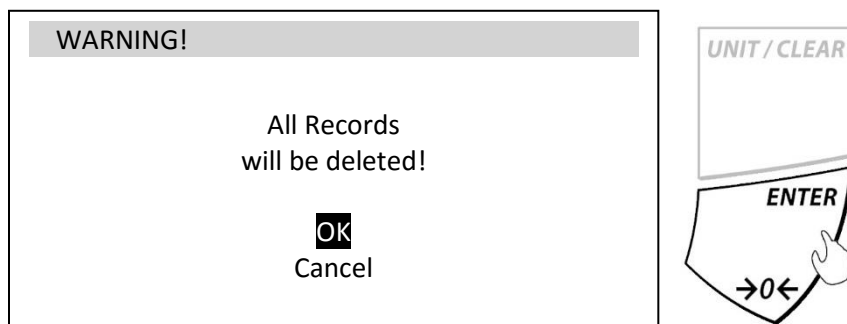

# Chapter 11: Measurement Settings

- To access the Measurement Settings menu, press the Menu key, select Measur. Settings and press the Enter key.

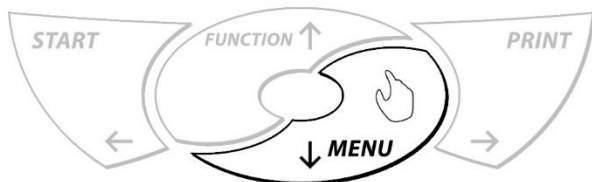

**USER MENU**

- Applications
- Data Manager
- Measur. Settings**
- Configuration
- Calibration
- Info
- Exit

- Use the arrow keys to navigate through the features and configure the function.

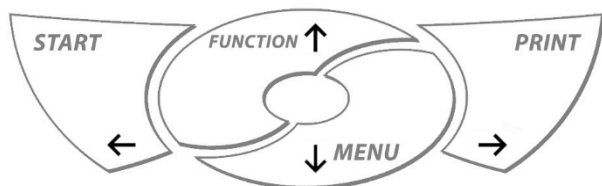

**MEASUR. SETTINGS**

- Record & Speed
- Units
- Auto Zeroing
- Threshold
- Direction
- Exit

## 11.1 Record & Speed

- To change the torque gauge capturing speed and measurement record format, select Record & Speed from the Measurement Settings menu and press the Enter key.

**MEASUR. SETTINGS**

- Record & Speed
- Units
- Auto Zeroing
- Threshold
- Direction
- Exit

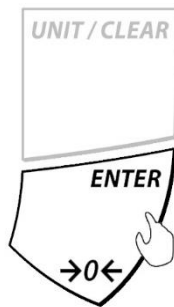

- To configure the torque gauge speed at which measurements are captured select Speed and press the Enter key. Use the navigation keys to key in a desired speed rate. Higher capture speed decreases the maximum Sampling Time and Total number of measurements that can be captured in a sequence.

RECORD & SPEED	
1. Speed:	0.001 s
2. Record	< R/-, R/D & T >
3. Exit	
Hz = 1000	
Samp. Time = 71.9 s	
MaxSamp. = 71936	

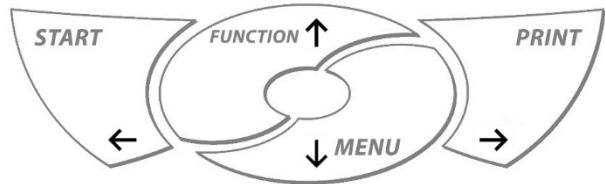

### Speed Settings

	Maximum Speed	Minimum Speed
<b>FSA Model</b>	0.0010 s	100.000 s

- To change the record format of captured measurements, use the navigation keys to select Record and press the Enter key.

RECORD & SPEED	
1. Speed:	0.001 s
2. Record:	< R/-, R/D&T >
3. Exit	
Hz = 1000	
Samp. Time = 71.9 s	
MaxSamp. = 71936	

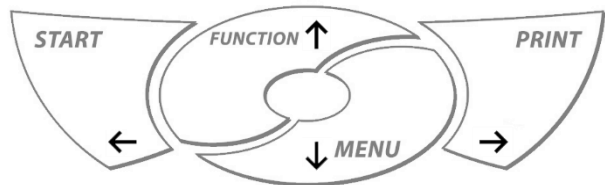

### Measurement Record Format Settings

<b>R/-</b>	Captured measurement does not include date and time stamping
<b>R/D &amp; T</b>	Each captured measurement is stamped with date and time.

- Hertz, Sampling Time, and Maximum number measurements are automatically recalculated after the Speed and Record parameters are changed.

## 11.2 Units – Selecting default unit of measure

- To select a torque gauge default unit of measure, select Units from the Measurement Settings menu and press the Enter key.

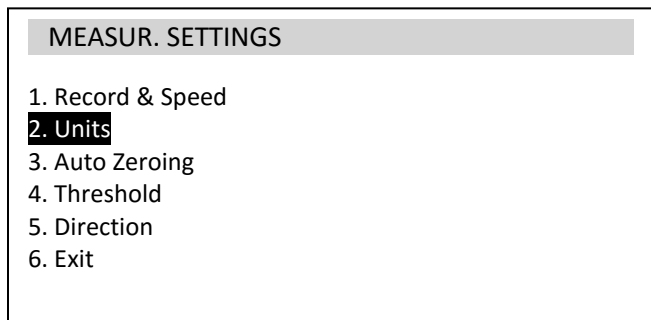

- To select a default unit of measure, use the navigation keys to select a desired unit and press the Enter key to place a checkmark corresponding to the unit.

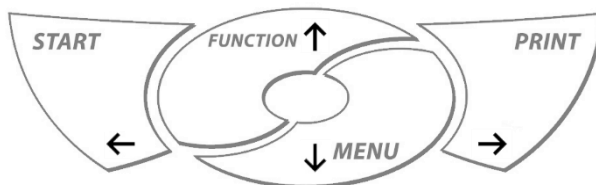
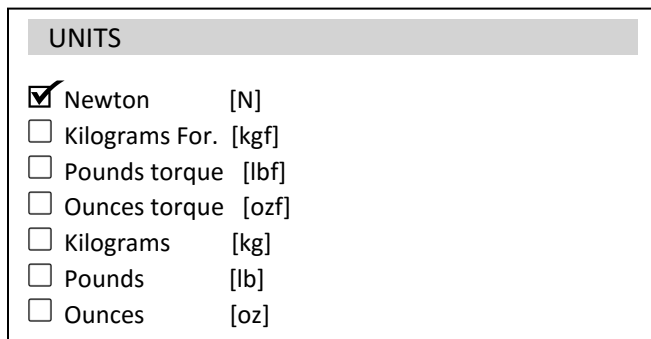

### 11.3 Auto Zeroing

- To adjust the Auto-Zero select Auto Zeroing from the Measurement Settings menu and press the Enter key. Auto Zeroing automatically maintains zero of the torque gauge, if the load cell is not affected by any external torque or if the zero was set by pressing the →0← key.

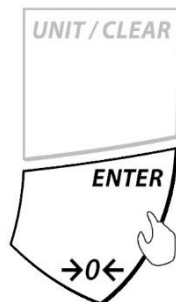
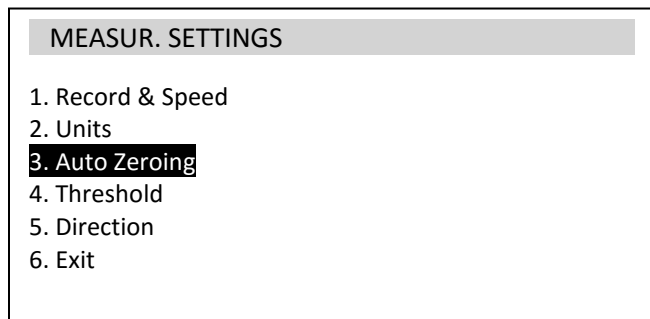

- To disable or enable Auto Zeroing, use the navigation keys to select Status and press the Enter key.

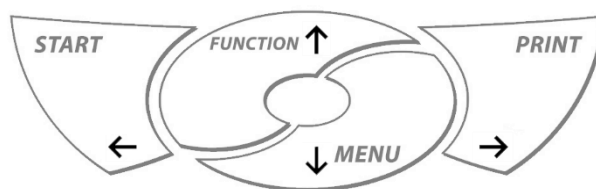
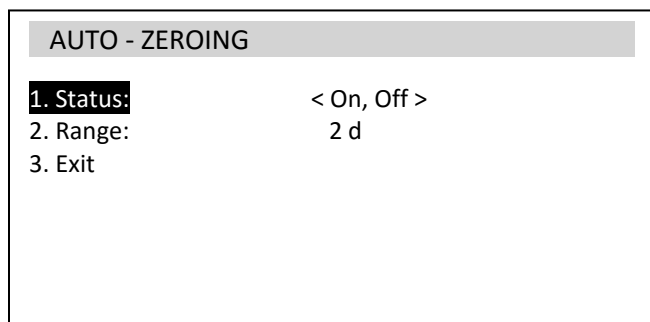

- To change the Auto Zeroing range, use the navigation keys to select Range and press the Enter key. Key in an autozeroing value between 1d and 100d.

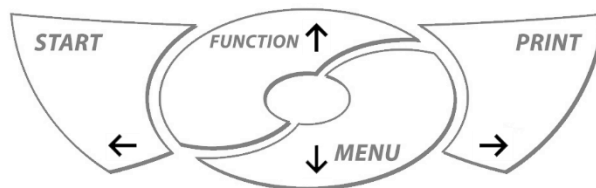
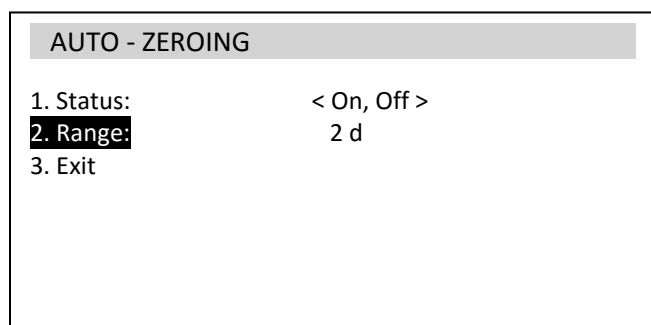





## 11.4 Threshold – Output Port and Internal Buzzer

- To enable the Threshold Output port and buzzer signaling for threshold limits, select Threshold from the Measurement Settings menu and press the Enter key.

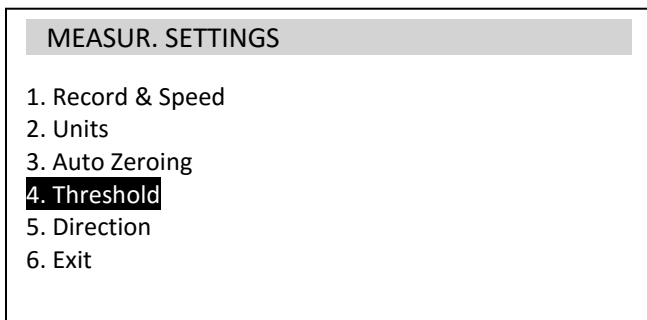

- To enable the output port, use the navigation keys to select Status and press the Enter key.

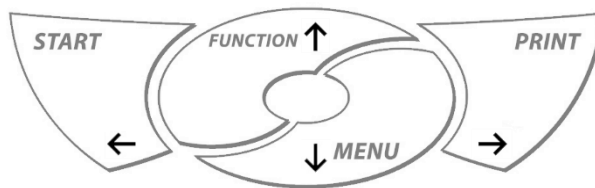
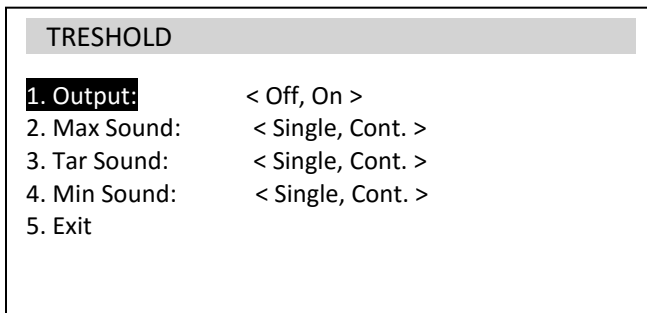

- To enable and configure buzzer signaling, use the navigation keys to select a threshold limit and press the enter key.

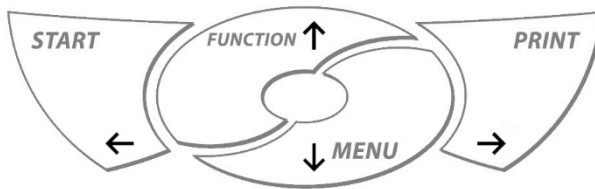
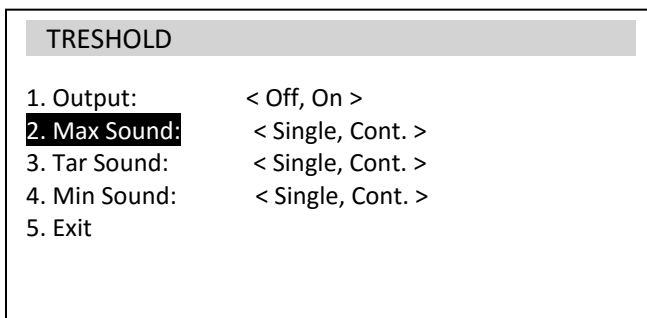

### Threshold Limit Buzzer Settings

<i>Single</i>	Buzzer sounds once when the limit is reached
<i>Continuous</i>	Buzzer makes a continuous sound when the limit is reached



## 11.5 Direction – Reversing Compression and Tension

- To reverse the direction between tension and compression, select Direction from the Measurement Settings menu and press the Enter key.

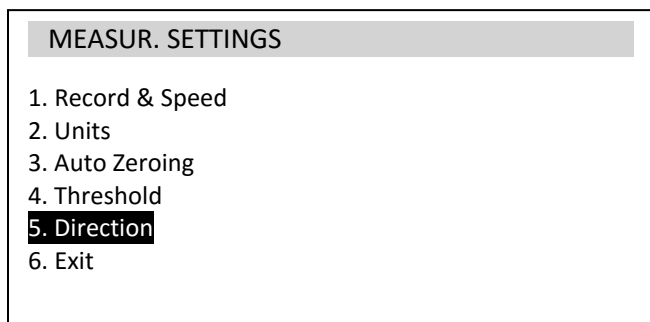

- Use the navigation keys to select Status and press the Enter key.

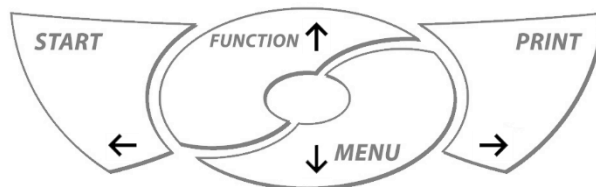
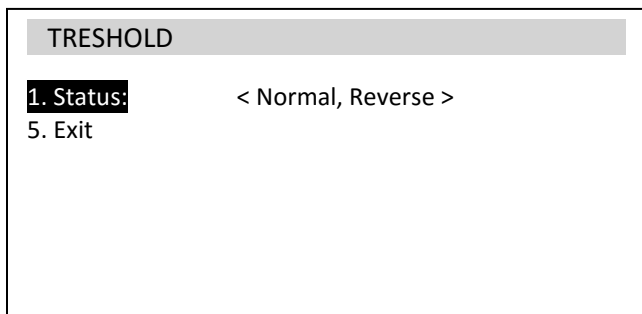

<b>Normal</b>	compression torque push is positive ( + )   tensions torque pull is negative ( - )
<b>Reverse</b>	compression torque push is negative ( - )   tensions torque pull is positive ( + )

## Chapter 12: Configuration

1. To access the Configuration menu, press the Menu key, select configuration and press the Enter key.

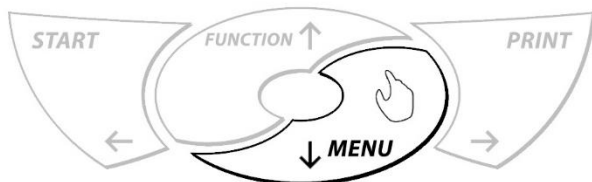

### USER MENU

1. Applications
2. Data Manager
3. Measur. Settings
- 4. Configuration**
5. Calibration
6. Info
7. Exit

2. Use the arrow keys to navigate through the features and configure the function.

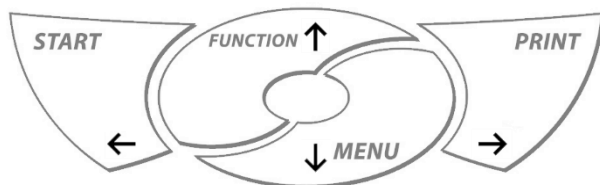

### CONFIGURATION

1. Printout
2. Gauge Change
2. Interface
3. LCD Settings
4. Time & Date
5. Keypad
6. Auto-Off
7. Battery
8. External Input
9. Firmware Update
10. Defaults
11. Exit

## 12.1 Printout

1. To configure printing parameters and print details select Print from the Configuration menu and press the Enter key

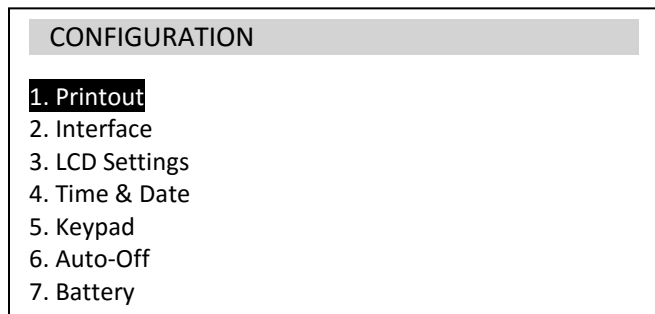

2. To enable or disable printable parameters use the navigation keys to select a desired parameter and press the Enter key to place or remove a checkmark corresponding to the parameter. Disabled parameters will not appear on the receipt printout and will not be transited via interface ports.

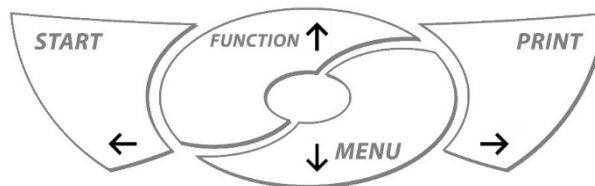
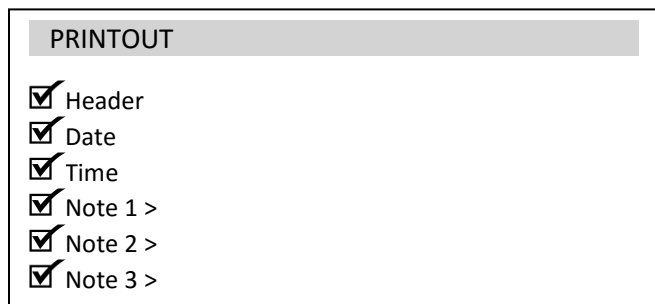

3. To key in printable custom notes, select a Note slot and press the right arrow key. Use the arrow key to select characters and input notes. Use the Enter key to save.

<b>Header</b>	torque Gauge Model and Serial Number
<b>Date</b>	Current Date
<b>Time</b>	Current Time
<b>Note 1, 2, 3</b>	Custom Notes and Remarks
<b>Number</b>	Printout Number
<b>Signature</b>	Signature Line

## 12.2 Interface (RS232, USB, Wireless)

- To configure baudrates and other PC interface parameters, select Interface from the configuration menu and press the Enter key



- Select a desired port and press the Enter key. Use the navigation keys to select port parameters and press the Enter key to save the settings. To change the transmission data format mode select Sending and choose a desired sending mode.

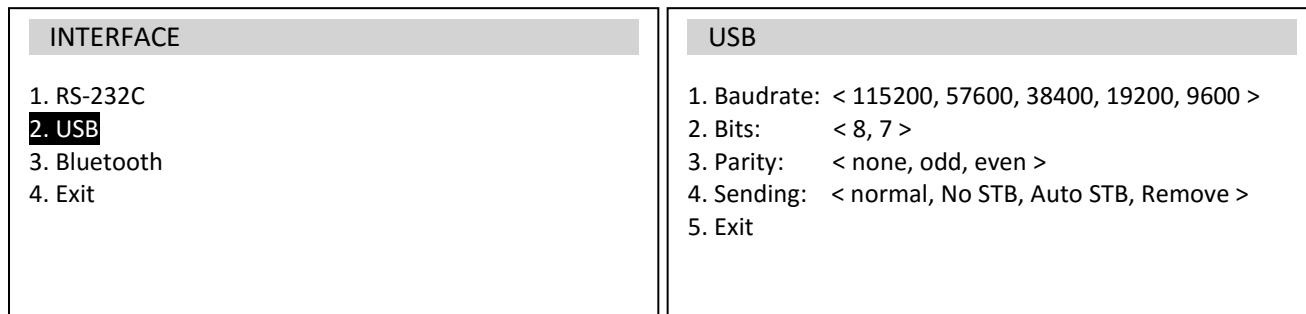

### Transmission data format mode

Normal	Stable Result Required	Stable weighing result is required before data is sent
No STB	No Stability Required	Result is sent as soon as the transfer data button is pressed. torque Gauge does not wait for a stable result
Auto STB	Automatic	Weighing result is automatically transferred from the torque gauge after it stabilizes (no push key required)
Remove	Remove All Characters	All none torque result characters are removed. torque gauge sends only numeric values. Date, Time, Unit of measure are removed.
Contin.	Continuously	torque measurement results are continuously transferred from the torque gauge always. (no push key and no stability required)



- To enable the Wireless transmitter, select Bluetooth and press the Enter key. Select Status and use the navigation keys to select ON. (Available on FC models only)

<p><b>INTERFACE</b></p> <ol style="list-style-type: none"> <li>RS-232C</li> <li>USB</li> <li><b>Bluetooth</b></li> <li>Exit</li> </ol>	<p><b>BLUETOOTH</b></p> <ol style="list-style-type: none"> <li>Status: &lt; On, Off &gt;</li> <li>Sending: &lt; normal, No STB, Auto STB, Remove &gt;</li> <li>Exit</li> </ol>
--	--

### 12.3 LCD Settings

- To adjust LCD contrast and configure backlight settings select LCD Settings from the Configuration menu and press the Enter key.

<p><b>CONFIGURATION</b></p> <ol style="list-style-type: none"> <li>Printout</li> <li>Interface</li> <li><b>LCD Settings</b></li> <li>Time &amp; Date</li> <li>Keypad</li> <li>Auto-Off</li> <li>Battery</li> </ol>
--



- Use the navigation keys to select and configure LCD settings.

<p><b>USB</b></p> <ol style="list-style-type: none"> <li>Contrast: <input type="text"/></li> <li>Backlight: &lt; BAT, On, Off, ECO &gt;</li> <li>Direction: &lt; Auto, Up, Down &gt;</li> <li>Time LCD: &lt; On, Off &gt;</li> <li>Exit</li> </ol>
--

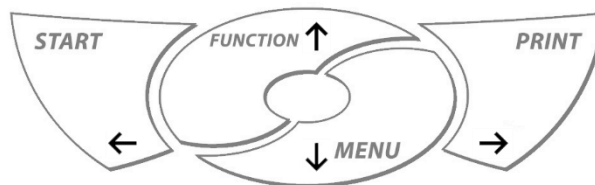



### Backlight Settings

<b>BAT</b>	The backlight is turned off after 30 seconds of inactivity to preserve battery life.
<b>ON</b>	The backlight is always on.
<b>OFF</b>	The backlight is always off.
<b>ECO</b>	The backlight can be turned on by holding the backlight key on the main keyboard.

### LCD Direction Settings

<b>UP</b>	The screen is always upright
<b>DOWN</b>	The screen is always upside down.
<b>AUTO</b>	The screen automatically adjusts to the direction the torque gauge is being held.

### Time LCD Settings

<b>ON</b>	Date and time is shown on the LCD
<b>DOWN</b>	Date and time in

## 12.4 Time & Date

- To adjust the torque gauge Time and Date select Time & Date from the configuration menu and press the Enter key.

CONFIGURATION	
1. Printout	
2. Interface	
3. LCD Settings	
<b>4. Time &amp; Date</b>	
5. Keypad	
6. Auto-Off	
7. Battery	



- Use the navigation keys to select and change the time settings.

TIME & DATE	
1. Time:	11:45:30 AM
2. Date:	11 – 29 – 2016
3. 12 / 24:	< 12H, 24H >
4. Format:	< MM-DD-YYYY, DD-MM-YYYY >
5. Exit	

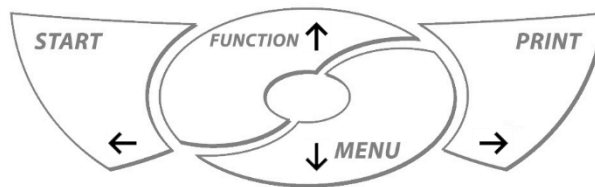



## 12.5 Keypad – Disabling and Enabling Buzzer Feedback

- To enable or disable the keypad buzzer feedback select Keypad from the Configuration menu and press the Enter key.

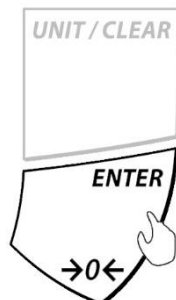
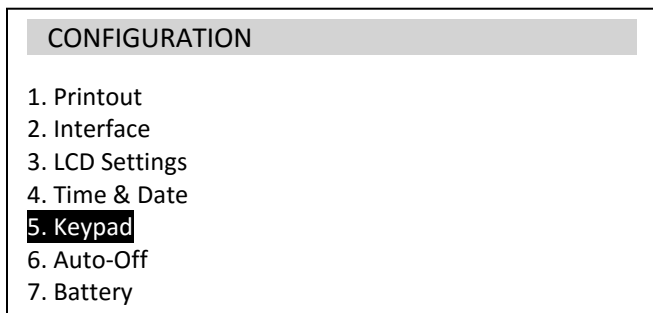

- Use the navigation keys to select Sound and select On to enable the keypad buzzer or Off to disable it.

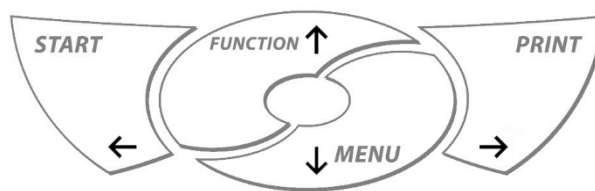
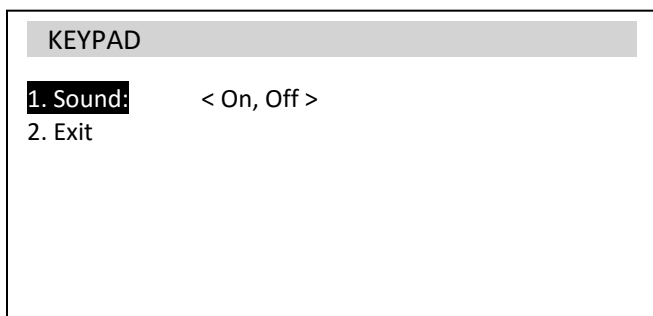

## 12.6 Auto-Off – Power Save Settings

- To configure battery power-save options, select Auto-Off from the Configuration menu and press the Enter key.

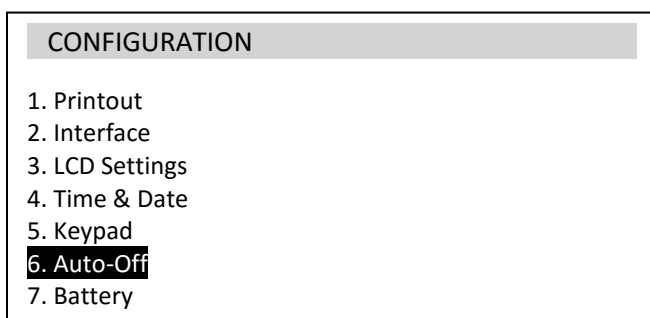



- Use the navigation keys to select Status and press the Enter key to change the setting.

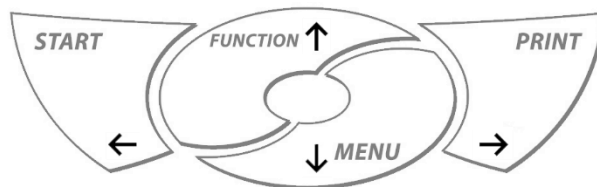
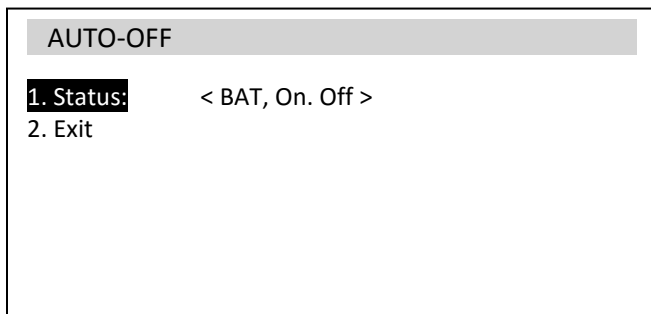

### Auto-Off Power Save Settings

<b>BAT</b>	The torque gauge will shut off automatically when the battery is low.
<b>ON</b>	The torque gauge automatically shuts off after 5 minutes of inactivity.
<b>OFF</b>	The torque gauge will only turn off when the user presses the ON/OFF key.

## 12.7 Battery – Disabling Charging

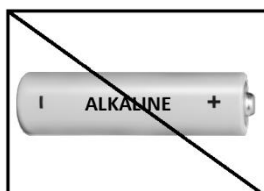

**Always disable charging before installing disposable batteries.**

**Charging non-rechargeable, alkaline batteries can be hazardous and cause damage to the torque gauge.**

- To disable charging select Battery from the Configuration menu and press the Enter key

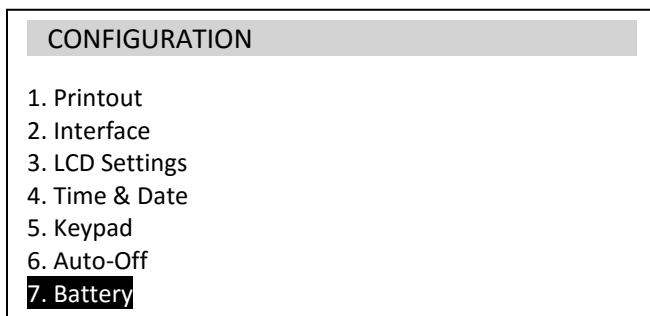



- Use the navigation keys to select Charging and press the Enter key to change the setting.

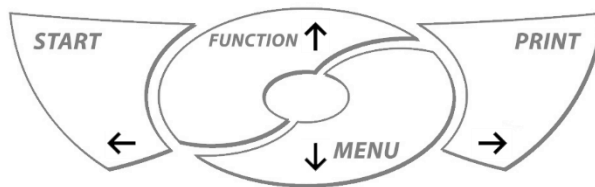
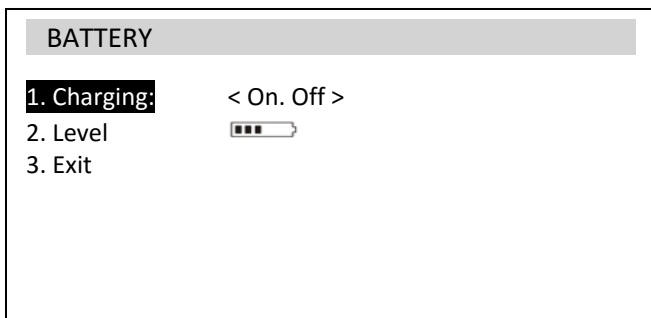

### 12.8 External Input – Remote Triger

- To Enable the Input port which allows sending external button or a pedal to be used as trigger for starting torque measurements, select External Input from the Configuration menu and press the Enter key.

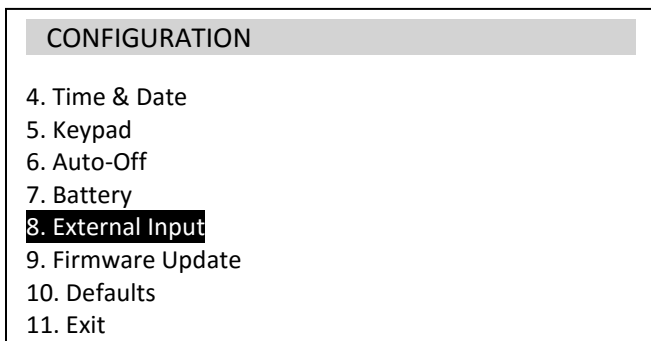

- Use the navigation keys to select Status and press the Enter key to change the setting.

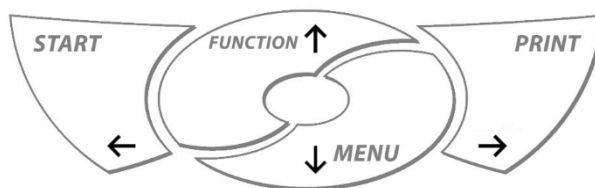
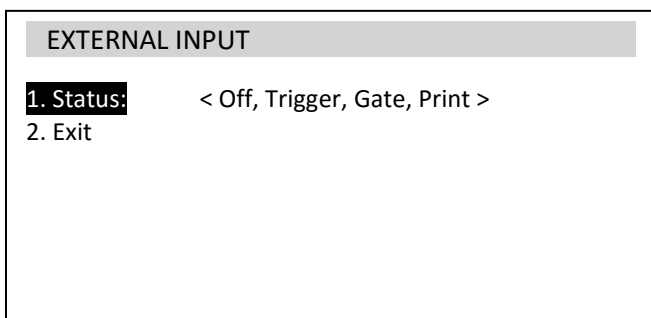

<b>Off</b>	Externa input port is disabled
<b>Trigger</b>	Capturing measurements or starting measurement sequence is initiated single external signal.
<b>Gate</b>	Measurements are captured only when the input port is enabled
<b>Print</b>	Single external signal initiates the Print command.



## 12.9 Firmware Update

Before updating the torque gauge firmware please contact technical support for assistance.

To update the firmware, the torque gauge must be connected to a PC via the USB port. A firmware update must be enabled simultaneously through Torbal Utility software on the PC as well as the Firmware option on the torque gauge.

1. To initiate the firmware update, select Firmware Update from the Configuration menu and press the Enter key.

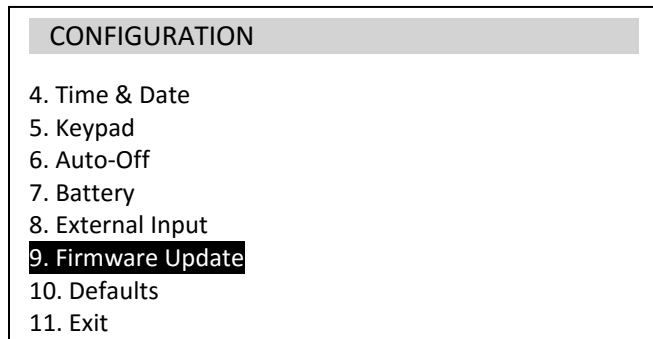

2. Use the navigation keys to select Yes and press the Enter key.

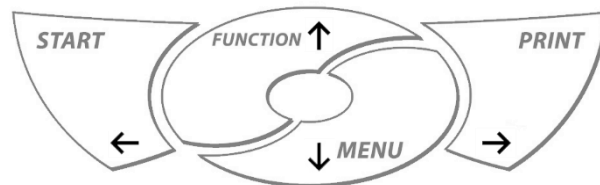
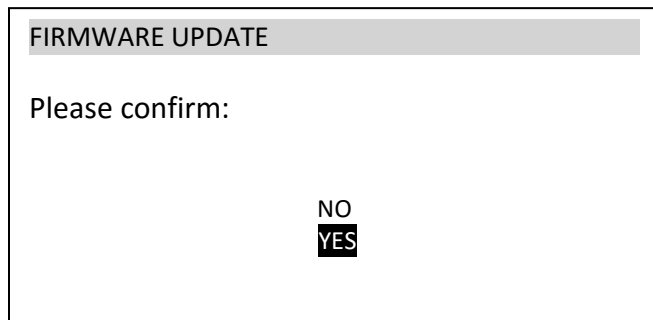

## 12.10 Defaults

1. To reset all modes and applications as well as restore default factory settings, select Defaults from the Configuration menu and press the Enter key.

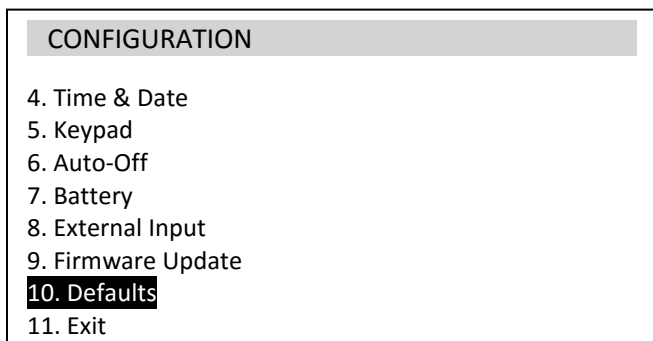

2. Use the navigation keys to select Yes and press the Enter key.

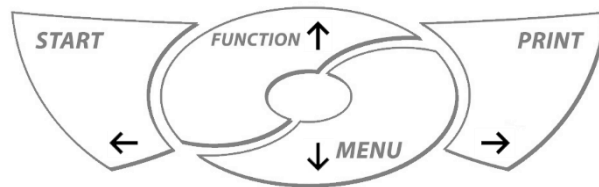
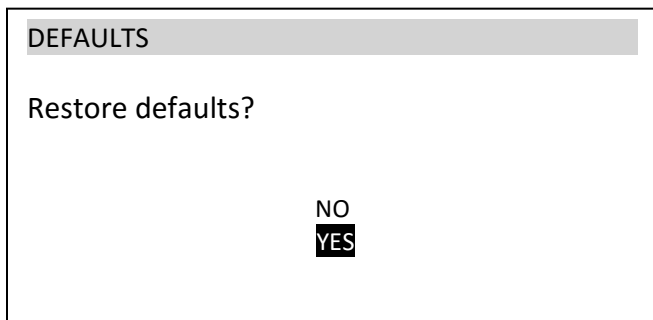

# Chapter 13: Calibration

To access the calibration menu, press the Menu key, select Calibration and press the Enter key.

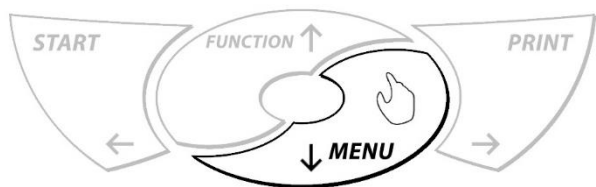

**USER MENU**

1. Applications
2. Data Manager
3. Measur. Settings
4. Configuration
- 5. Calibration**
6. Info
7. Exit

## 13.1 Calibrating with Mass or torque

1. Position the device loadcell sensor and attach required calibration tooling. The gauge and sensor should be firmly secured.
2. Select Mode and the unit of measure (LOAD or TORQUE)

**CALIBRATION**

1. Calibration            START
2. **Mode:**                < N/kN, kgf, lbf, ozf, kg, lb, oz >
3. torque:                < 200 N, ... >
4. g [ m/s<sup>2</sup>]:            < 9.81416 >
5. Geogr. Location    < Latitude: 54°21', Elevation 114m >
6. Correction            < + 0.00N >
7. Load-Cell            < MAX = 0 kg, SENS=0.00000 mV/V >
8. Factory Calibr.    < Yes, No >
9. PIN                    < \*\*\*\*\* >
10. Exit

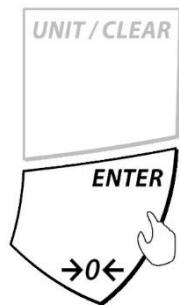

3. Select the *Load or torque* equal exactly to the weight or torque of the calibration standard that will be used to calibrate. To enter a custom load or torque value, press the right arrow key and key in the calibration value.



CALIBRATION	
1. Calibration	START
2. Mode:	< N/kN, kgf, lbf, ozf, kg, lb, oz >
3. torque:	< 200 N, ... >
4. g [ m/s <sup>2</sup> ]:	< 9.81416 >
5. Geogr. Location	< Latitude: 54°21', Elevation 114m >
6. Correction	< + 0.00N >
7. Load-Cell	< MAX = 0 kg, SENS=0.00000 mV/V >
8. Factory Calibr.	< Yes, No >
9. PIN	< ***** >
10. Exit	

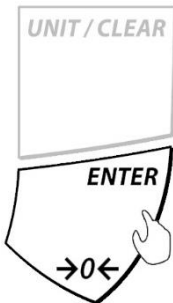

4. Select *Calibration – START* and press the Enter key to initiate calibration.

CALIBRATION	
1. Calibration	START
2. Mode:	< N/kN, kgf, lbf, ozf, kg, lb, oz >
3. torque:	< 200 N, ... >
4. g [ m/s <sup>2</sup> ]:	< 9.81416 >
5. Geogr. Location	< Latitude: 54°21', Elevation 114m >
6. Correction	< + 0.00N >
7. Load-Cell	< MAX = 0 kg, SENS=0.00000 mV/V >
8. Factory Calibr.	< Yes, No >
9. PIN	< ***** >
10. Exit	

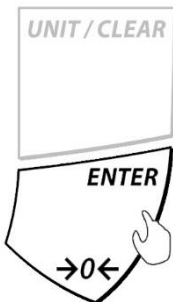

5. Press the enter key to start the calibration process.

CALIBRATION	200N
Press ENTER	

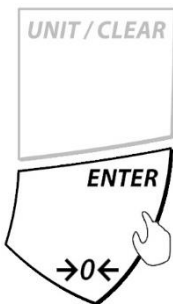

6. When prompted place the calibration load on the hook or hook-held platform attached to the sensor and press Enter. Wait for the calibration process to complete.

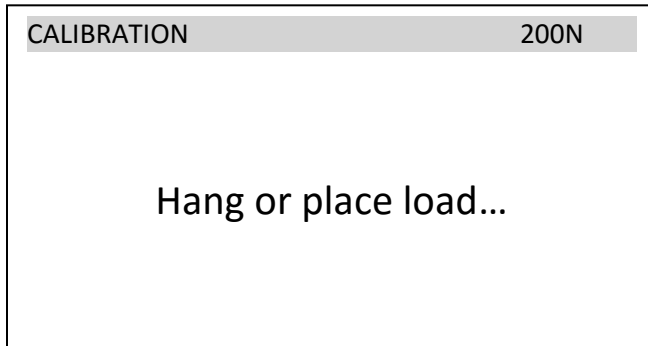

7. When prompted, key in your local Gravitational Acceleration Value and press the Enter key to complete the calibration process.

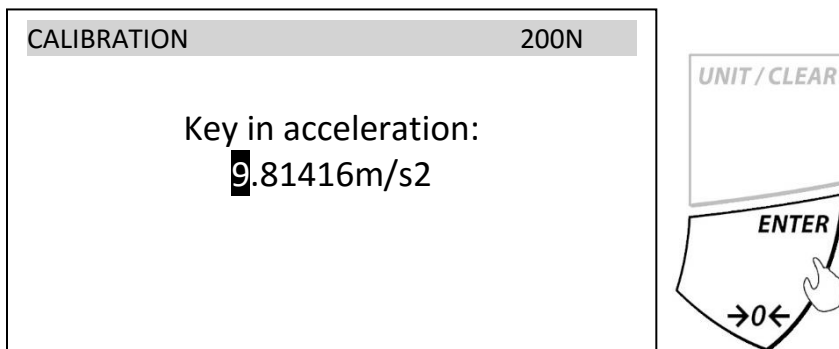

### 13.2 Setting Gravitational Acceleration Value

1. To calibrate the torque gauge using the navigation keys to select g [ m/s<sup>2</sup> ] and press the Enter key.

CALIBRATION	
1. Calibration	START
2. Mode:	< N/kN, kgf, lbf, ozf, kg, lb, oz >
3. torque:	< 200 N, ... >
4. g [ m/s <sup>2</sup> ]:	< 9.81416 >
5. Geogr. Location	< Latitude: 54°21', Elevation 114m >
6. Correction	< + 0.00N >
7. Load-Cell	< MAX = 0 kg, SENS=0.00000 mV/V >
8. Factory Calibr.	< Yes, No >
9. PIN	< ***** >
10. Exit	

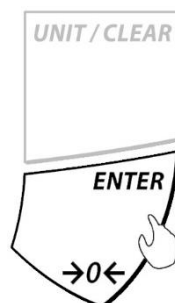

2. Use the navigation keys to key in the gravitational acceleration for the location area the torque gauge is used in. The g-value of a given location can be found on the web. (e.g. Wikipedia, local municipality site, etc.) If the g-value cannot be obtained, the geographical coordinates can be entered to calculate the g-value automatically.

### 13.3 Using Geographical Location Coordinates

1. To key in the Geographical Coordinates for the area the torque gauge is used in, select Geogr. Location and press the Enter key.

CALIBRATION	
1. Calibration	START
2. Mode:	< N/kN, kgf, lbf, ozf, kg, lb, oz >
3. torque:	< 200 N, ... >
4. g [ m/s <sup>2</sup> ]:	< 9.81416 >
5. Geogr. Location	< Latitude: 54°21', Elevation 114m >
6. Correction	< + 0.00N >
7. Load-Cell	< MAX = 0 kg, SENS=0.00000 mV/V >
8. Factory Calibr.	< Yes, No >
9. PIN	< ***** >
10. Exit	



2. Enter the *Latitude* of the current location and press Enter to continue.
3. Enter the *Elevation* of the current location and press Enter to save. The g-value will be automatically updated.



### 13.4 Setting a Correction Value

1. Position the device loadcell sensor and attach required calibration tooling. The gauge and sensor should be firmly secured.
2. Place the calibration load on the hook or hook-held platform attached to the loadcell sensor.

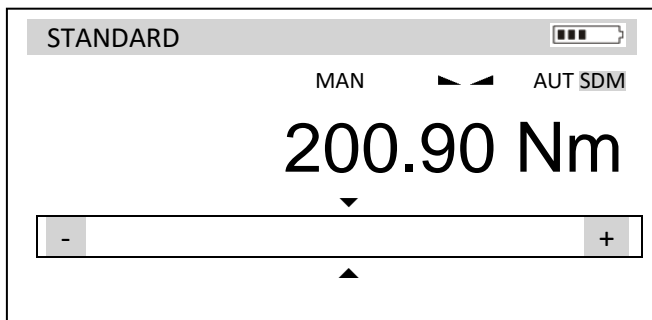

3. Note the difference between the known calibration load and the measured load.
4. Select *Correction* and key in the noted difference.

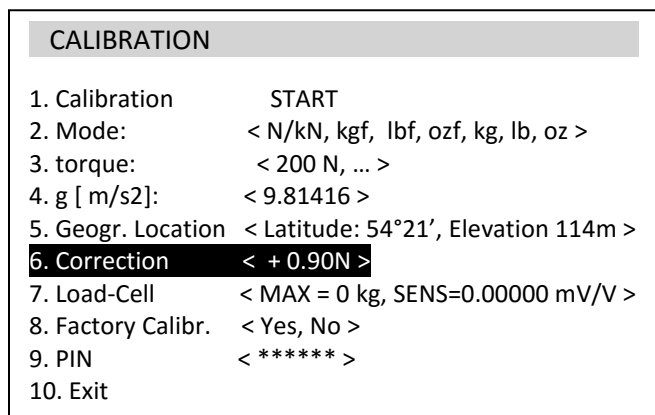

### 13.5 Setting Load Cell Sensitivity mV/V (Use when interchanging load-cells)

- To key in load-cell MAX and mV/V sensitivity values, use the navigation keys to select Load-cell and press the enter key

CALIBRATION	
1. Calibration	START
2. Mode:	< N/kN, kgf, lbf, ozf, kg, lb, oz >
3. torque:	< 200 N, ... >
4. g [ m/s <sup>2</sup> ]:	< 9.81416 >
5. Geogr. Location	< Latitude: 54°21', Elevation 114m >
6. Correction	< + 0.90N >
<b>7. Load-Cell</b>	<b>&lt; MAX = 0 kg, SENS=0.00000 mV/V &gt;</b>
8. Factory Calibr.	< Yes, No >
9. PIN	< ***** >
10. Exit	



- Use the navigation keys to key in the MAX value of the load-cell and press the Enter key to continue.
- Use the navigation keys to key in the mV/V SENS (sensitivity) value of the loadcell and press the Enter key.

**MAX and mV/V values are located on the load-cell nameplate or Calibration Certificate.**

### 13.6 Restoring Factory Calibration

- To restore factory calibration select Factory Calibr. and press the Enter key.

CALIBRATION	
1. Calibration	START
2. Mode:	< N/kN, kgf, lbf, ozf, kg, lb, oz >
3. torque:	< 200 N, ... >
4. g [ m/s <sup>2</sup> ]:	< 9.81416 >
5. Geogr. Location	< Latitude: 54°21', Elevation 114m >
6. Correction	< + 0.90N >
7. Load-Cell	< MAX = 0 kg, SENS=0.00000 mV/V >
<b>8. Factory Calibr.</b>	<b>&lt; Yes, No &gt;</b>
9. PIN	< ***** >
10. Exit	





- Use the navigation keys to select Yes and press the Enter key to proceed.

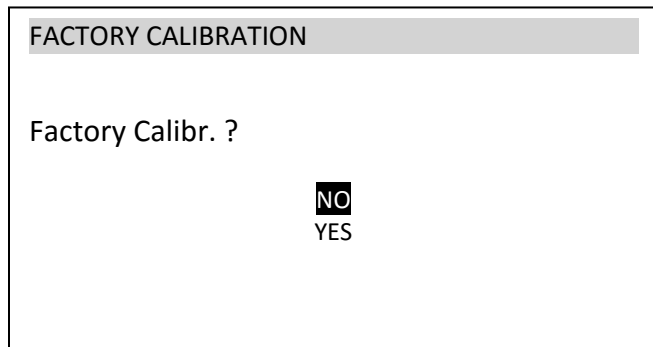

### 13.7 Calibration PIN Access

- To enable PIN access to the calibration menu select PIN and press the Enter key.

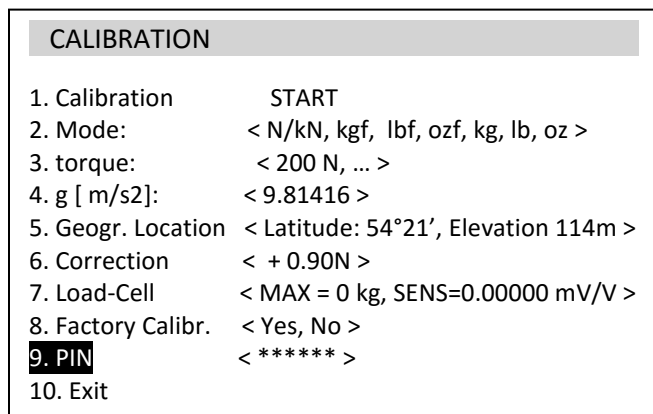

- Use the navigation to set a 6-digit calibration PIN. The PIN must be confirmed to become active. To disable PIN access change the PIN number to 000000

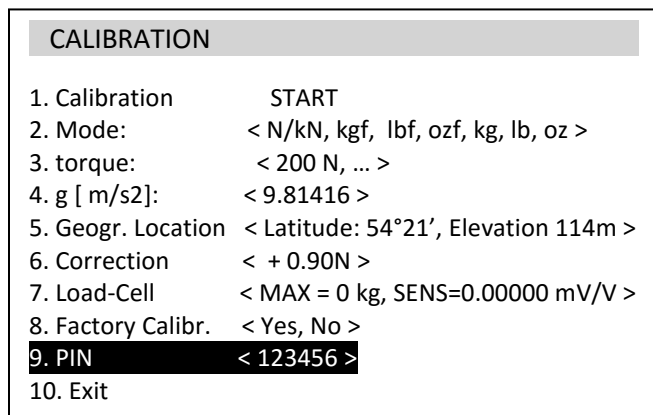

## Chapter 14: Torque Gauge Info

1. To verify the torque gauge firmware version and serial number, press the Menu key, select Info and press the Enter key.

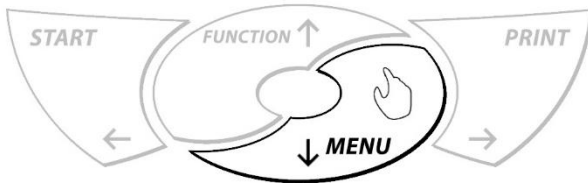

### USER MENU

1. Applications
2. Data Manager
3. Measur. Settings
4. Configuration
5. Calibration
- 6. Info**
7. Exit

2. torque gauge serial number, firmware and other important data will be displayed.

### INFO

Model : FSC2  
MAX : 2 Nm  
SOFT. : FCF008  
DATE : 2015.11.24  
S/N : F22002001031  
CARD : SDHC 3.69GB  
TORBAL

## Chapter 15: Connecting to PC - Communication Protocol

1. Before connecting the torque gauge to a computer, the USB Port must be configured with the appropriate baud rate and other necessary parameters.
2. Make sure you PC or Laptop is connected to the internet and allows drivers to be installed automatically.
3. Connect the torque gauge to the PC with a Standard A/B USB cable.

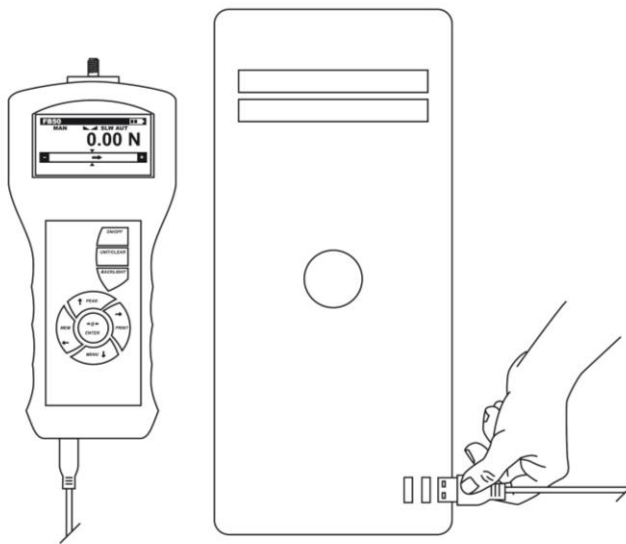

4. Allow the USB drivers to install automatically. If the driver does not install automatically, visit [torbalscales.com](http://torbalscales.com) to download and install the driver manually.

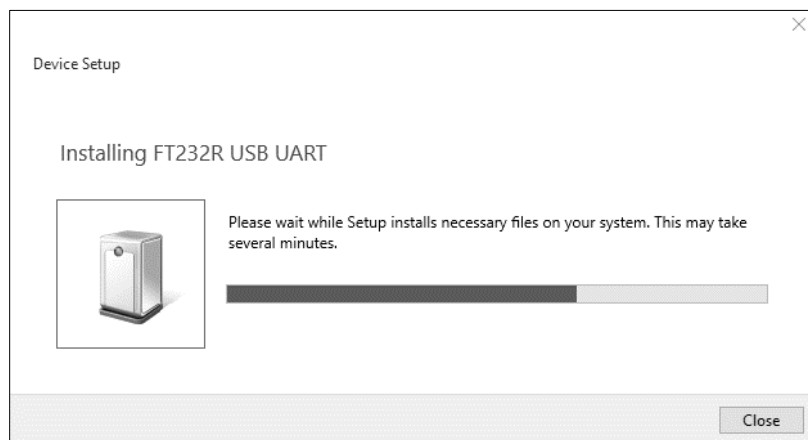

- Verify the COM port number assigned the torque gauge. Open the PC Device Manager, expand the Ports (COM & LPT) tab and locate the USB Serial Port (Note the COM port listed). The COM port is also listed in the FT232R USB UART device properties, which is visible in the Devices and Printers list, accessible from the computer’s control panel.

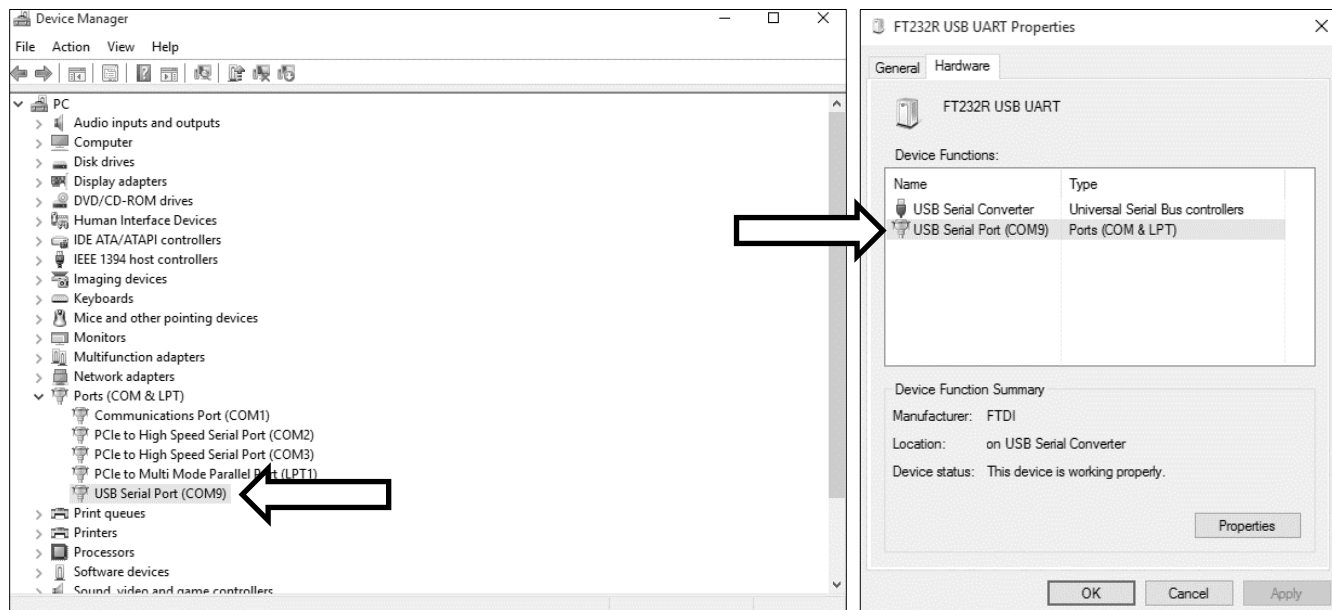

- Once the COM port number assigned to the torque gauge has been verified, open the software application and set the software connection to the COM port number listed in the PC device manager and the Baud Rate set in the torque gauge.

## 15.1 torque Gauge Communication Protocol

Computer → torque Gauge: ENQ = (S I CR LF), (53 h 49 h 0Dh 0 Ah),

torque Gauge → Computer: 16 Bytes, 8 bits, 1stop, no parity, 4800bps

Transmission initiation command (Print key) ENQ= (S I CR LF)

Use Sx1"+CR+LF to request data from PC without stable result.

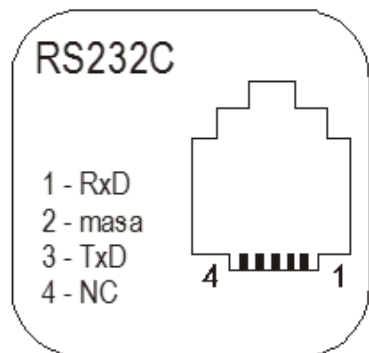

1	-	space or mark
2	-	Space
3÷4	-	digit or space
5÷9	-	digit, decimal point or space
10	-	Digit
11	-	Space
12	-	K,l,c,p or space
13	-	G,b,t,c or %
14	-	Space
15	-	CR
16	-	LF

# Chapter 16: Wireless PC Connection

1. To enable the Wireless transmitter, press the Menu key and select Configuration.

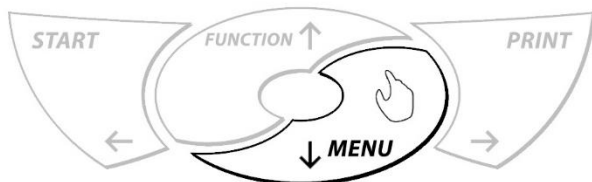

**USER MENU**

1. Applications
2. Data Manager
3. Measur. Settings
- 4. Configuration**
5. Calibration
6. Info
7. Exit

2. Use the navigation keys to select Interface and press the Enter key

**CONFIGURATION**

1. Printout
- 2. Interface**
3. LCD Settings
4. Time & Date
5. Keypad
6. Auto-Off
7. Battery



3. To enable the Wireless transmitter, select Bluetooth and press the Enter key. Select Status and use the navigation keys to select ON.

**INTERFACE**

1. RS-232C
2. USB
- 3. Bluetooth**
4. Exit

**BLUETOOTH**

1. Status: < On, Off >
2. Sending: < normal, No STB, Auto STB, Remove >
3. Exit





- 4. Make sure your PC is connected to the internet and allows drivers to be installed automatically. Plug in the dongle to an available USB slot in your PC. Windows will begin automatic installation of device driver software.

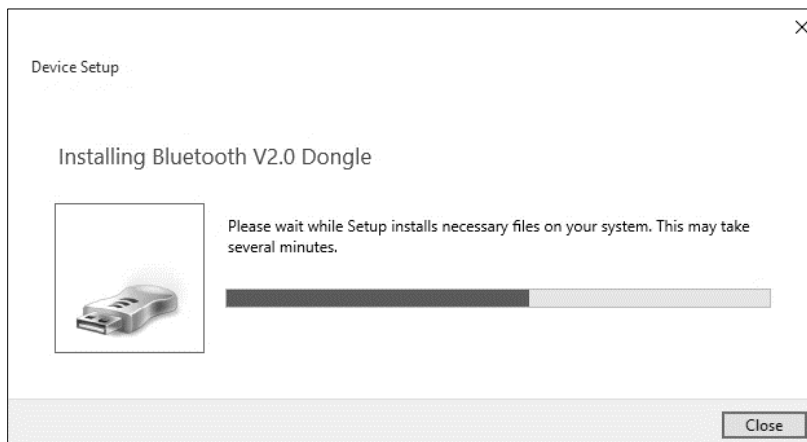

- 5. Once the driver is installed, a Bluetooth icon will be visible in the task bar. Right click on the Bluetooth icon. The icon may be hidden, in which case expand your task bar to show all inactive icons. From the icon function menu select "Add a Bluetooth Device" to start the pairing wizard.



- 6. Device window with available devices will appear on the PC screen. Locate device "FC..." torque gauge device, click once to select it, and click on Pair to proceed.

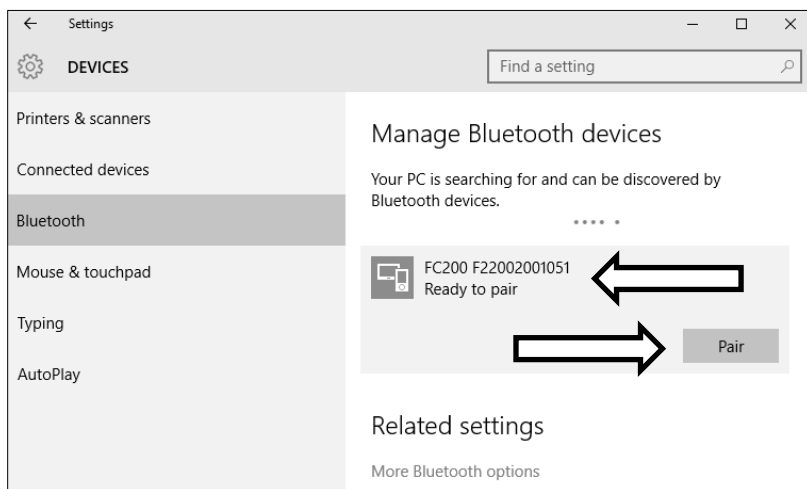

7. Key in the pairing code: 867225. Click next to pair the torque gauge with your computer.

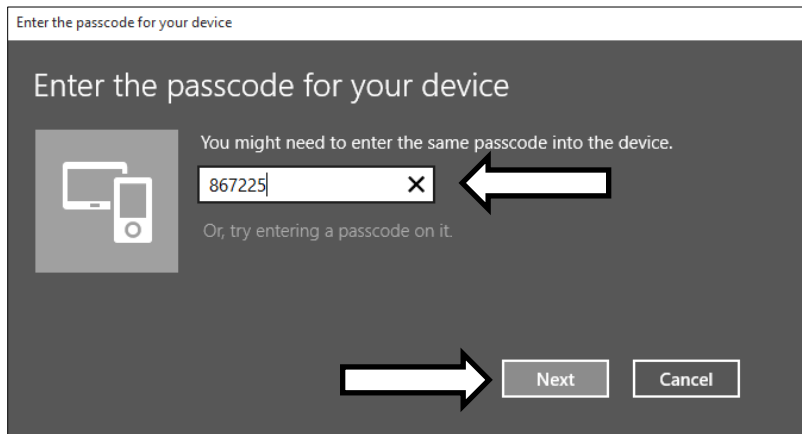

8. Click on the Bluetooth icon located in your task bar and select “open settings”.

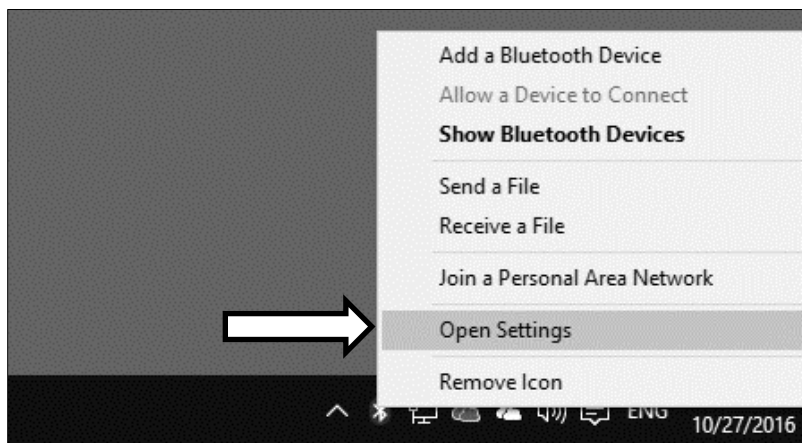

- For convenience check off option “show the Bluetooth icon in the notification area” in the Options tab. Click on the tab “COM ports”, the serial COM ports used by your computer for Bluetooth will be displayed. Note the outgoing COM port number for “FC... ‘SPP Dev’”. This is the COM port used the PC computer to transmit data between the torque gauge and the PC.

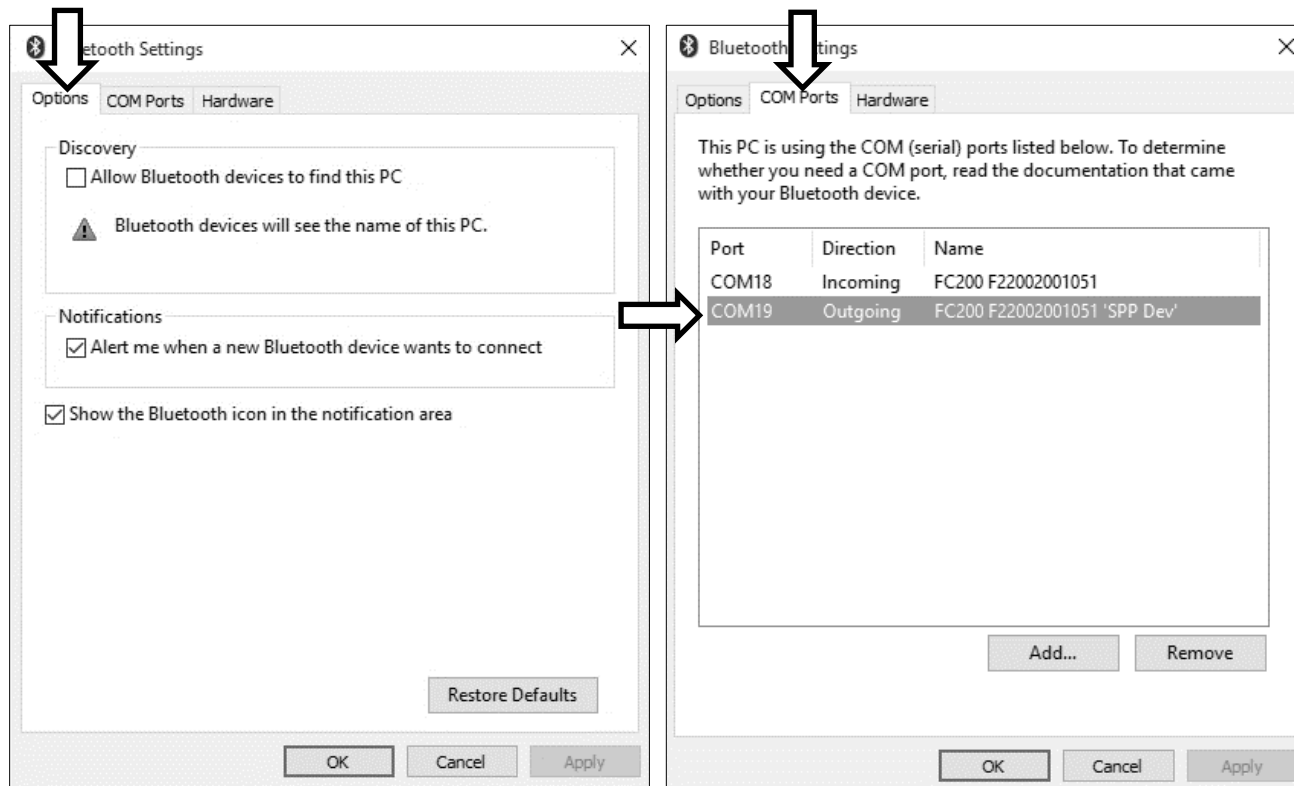

- Once the COM port number assigned to the torque gauge has been verified, open the software application and set the software connection to the COM port number listed in COM Ports Bluetooth settings. Use Baud Rate 115200.

# Chapter 17: Input / Output Port Configuration

The threshold output mode enables the Output port by sending voltage level signals which can be used for signaling or controlling external peripherals that can connect with the torque gauge. The output mode can be used in combination with Programmable Thresholds Monitoring. Input mode allows external button or a pedal to be used as trigger for starting torque measurements and taking samples.

OUTPUT Ampacity:  $I_{max}=25\text{mA}$  /  $U_{nom}=24\text{V}$  (open collector type, emitters connected– GND)

INPUT Voltage Range IN (+)/IN (-):  $U_{in}=12\text{-}18\text{V}$  /  $I_{in\ max}=50\text{mA}$

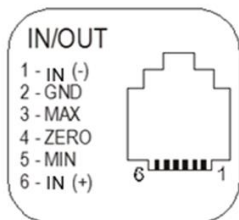

Outputs MAX and ZERO: Equivalent (common GND)

Recommended Power: 24V<sub>DC</sub>

MIN, MAX, ZERO Output Current:  $I_{out\ max} = 25\text{mA}$

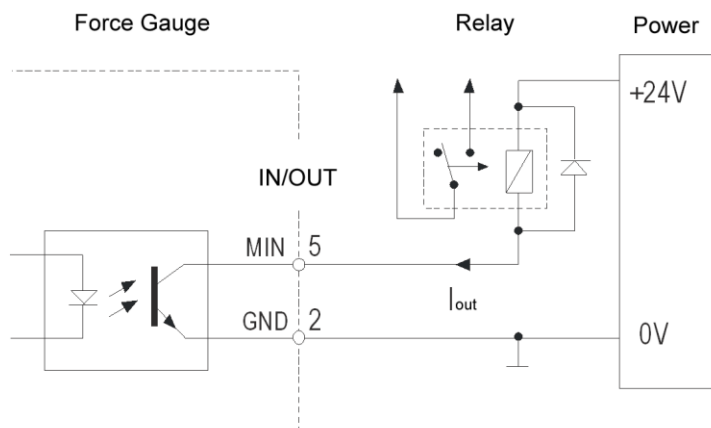

Supply voltage:  $U_{in} = 3 \div 6\text{V}$

Input current:  $I_{in} = 10 \div 20\text{mA}$  ( $I_{in\ max} = 50\text{mA}$ )

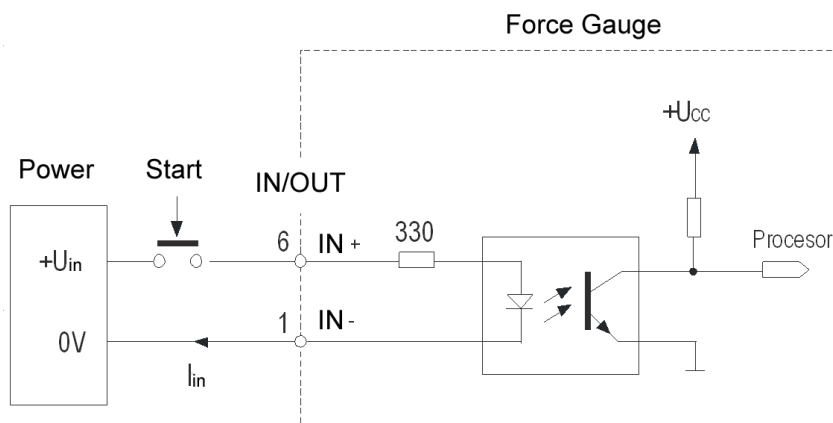



## Chapter 18: Common Errors and Troubleshooting

Error or Indicator	Cause	Explanation / Solution
ZEROING is displayed for an extended period.	The initializing process was interrupted	Don't move the torque gauge and press →0← ENTER key.
AD range exceeded (+/-)	The initializing process interrupted. Possible overload or load-cell damage	Put the gauge in horizontal position and turn it off and on using the ON/OFF key. Contact technical support.
The values indicated by the torque gauge differs significantly from the reference.	Calibration may be required.	Contact a servicing facility to calibrate the gauge.

## Chapter 19: Maintenance

### Cleaning and maintaining your torque gauge:

- Before cleaning the torque gauge always unplug the A/C adapter from the electrical outlet and remove the batteries.
- Use a soft, slightly damp cloth to clean the exterior housing of the torque gauge.
- Wipe the torque gauge gently. Do not allow any liquid to enter into the torque gauge.
- Do not apply extensive pressure to the LCD display.
- Do not use chemicals or benzene when cleaning the surface. Corrosive chemicals may damage the finish.

# Chapter 20: Technical Information, Measurements and Dimensions

FSA2 | FSA5 | FSA10

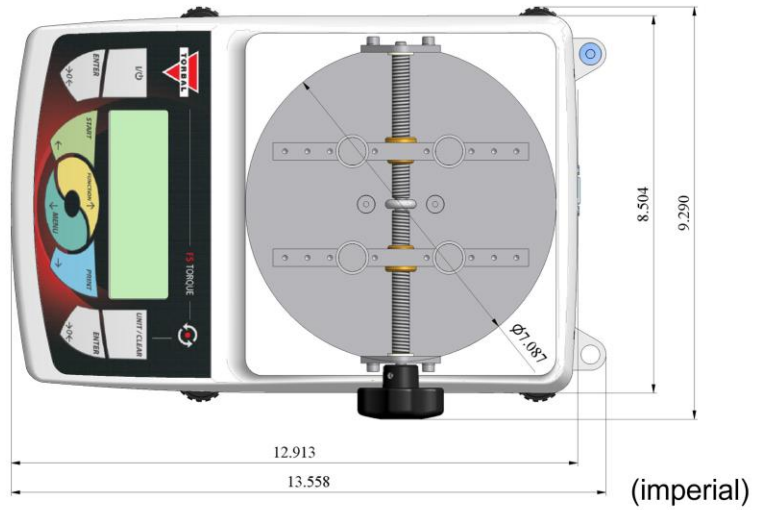
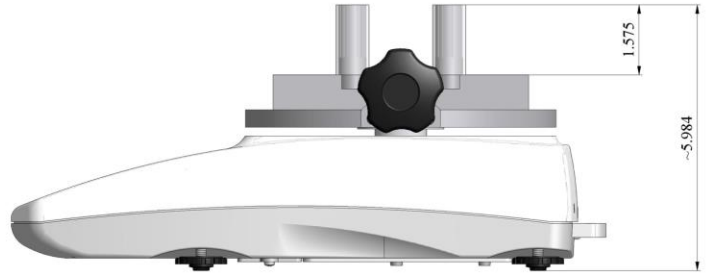

(imperial)

FSA2 | FSA5 | FSA10

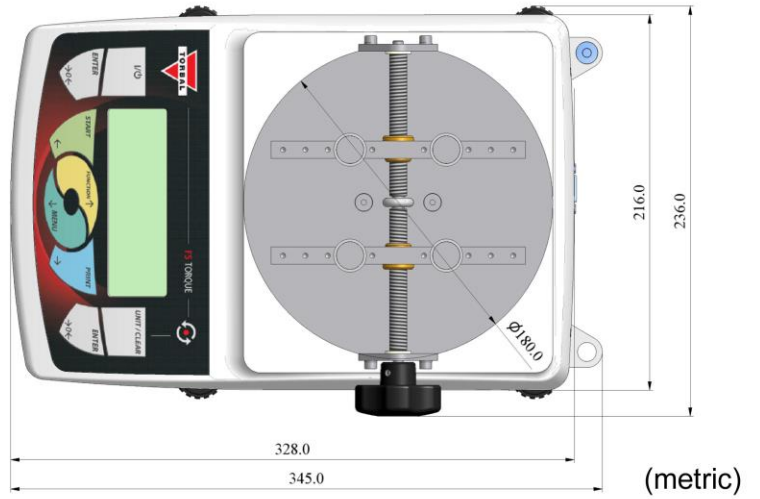
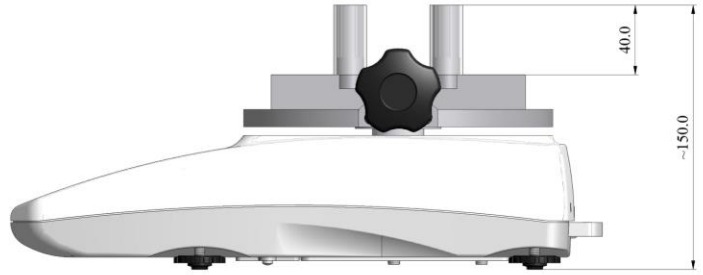





## Chapter 21: Limited Warranty

### PURCHASER'S WARRANTY

#### **Warranty is valid only if your product has been registered within 30 days of receipt**

This product is a precision device made to exacting standards of scientific accuracy. It is guaranteed to have been adjusted and inspected for proper workmanship and performance, and certified for its currently advertised specifications before shipment. Scientific Industries' Products are warranted against defects in material and workmanship under normal use and service. This warranty is extended only to the first purchaser. This limited warranty will not apply if, upon inspection, it is found that the product was tampered with, misused, overloaded, or abused, mishandled, placed in an improper environment, improperly installed or adjusted, used for a purpose other than that for which it was designed, or repaired by unauthorized personnel. Scientific Industries' liability under this warranty is limited to furnishing labor and parts necessary to remedy the defect covered by this warranty and restore the product to normal operating condition. Purchasers may be charged a minimum repair fee for in-warranty products returned for repair if those products are determined to be problem-free. To make a claim under this limited warranty, you must first obtain an RMA number from Scientific Industries and return the product carefully packed, in its original packaging, shipping prepaid, with the RMA number written on the return package.

EXCEPT FOR THE LIMITED WARRANTY PROVIDED HEREIN, ALL OTHER WARRANTIES, EXPRESS AND IMPLIED, INCLUDING MERCHANTABILITY AND FITNESS FOR A PARTICULAR PURPOSE, ARE DISCLAIMED. In all events, consequential, incidental, special and other damages are excluded and Scientific Industries, Inc. shall have no liability beyond the repair or replace limited warranty provided above.