

## Table of Contents

1. Cautionary Notes and Precautions.....	2
1.1 Important Handling Cautions and Warnings.....	3
2. Specifications.....	5
3. Keys, Display Indicators and Abbreviations.....	6
4. Parts Descriptions.....	7
5. Unpacking Balance and Getting Started.....	9
6. Basic Principles of Weighing.....	11
7. Battery Installation and Replacement.....	12
8. Functions, Descriptions and Definitions.....	13
9. Weighing.....	14
9.1. Weighing.....	14
9.2. Taring.....	14
9.3. Extending the Resolution.....	16
9.4. Zeroing the Scale.....	16
10. Auto-Zero.....	17
11. Parts Counting.....	18
11.1. Using the Default Sample Setting.....	18
11.2. Using a Custom Sample Size.....	19
11.3. Counting Based on a Known Individual Piece Weight.....	21
12. Units of Measure.....	23
13. Percent Weighing.....	26
14. Recipe Weighing.....	26
15. Calibration.....	29
15.1. Quick Calibration.....	29
15.2. Stepped Calibration.....	31
16. Port 1 - RS232 Communication Port Configuration.....	33
16.1. Data Transmission and Exchange Protocol.....	33
16.2. Baud Rate.....	35
16.3. Bites.....	35
16.4. Parity.....	36
17. Port 2 –USB Configuration.....	37
18. Receipt Printout.....	39
18.1. Enabling and Disabling Receipt Fields.....	40
18.2. Assigning Operator and Product ID Numbers.....	40
19. Dynamic and Animal Weighing LOC.....	41
20. Storing Tare Values.....	42
20.1. Storing a Tare Value Manually.....	42
20.2. Storing a Tare Value Automatically.....	43
20.3. Recalling a Previously Stored Tare Value.....	44
21. Min Max Weighing.....	45
22. Newton – Force Measurement.....	46
23. Filtering.....	47
24. Date and Time.....	48
24.1. Enabling and Disabling Date and Time Stamping.....	48
24.2. Setting the Current Date and Time.....	48
24.3. Enabling PIN access to the Date Configuration Function.....	50
25. Threshold Check Weighing and Opto-Isolator.....	51
25.1. Enabling Check Weighing and Setting Threshold Limits.....	51
26. Totalizing.....	53
27. Battery.....	55
28. LCD Backlight.....	56
29. Automatic Shutoff.....	57
30. Menu Customization.....	58
31. Restoring Default Settings.....	58
32. Common Errors and Troubleshooting.....	59
33. Maintenance.....	59
34. Limited Warranty.....	60

## Chapter 1: Cautionary Notes



Remember choose a proper location for you scale. Always handle the unit with care.

The correct location and proper environment make an important contribution to the accuracy of the weighing results of TORBAL industrial scales.

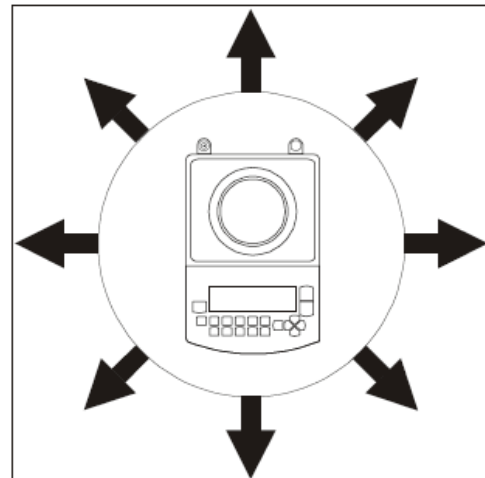
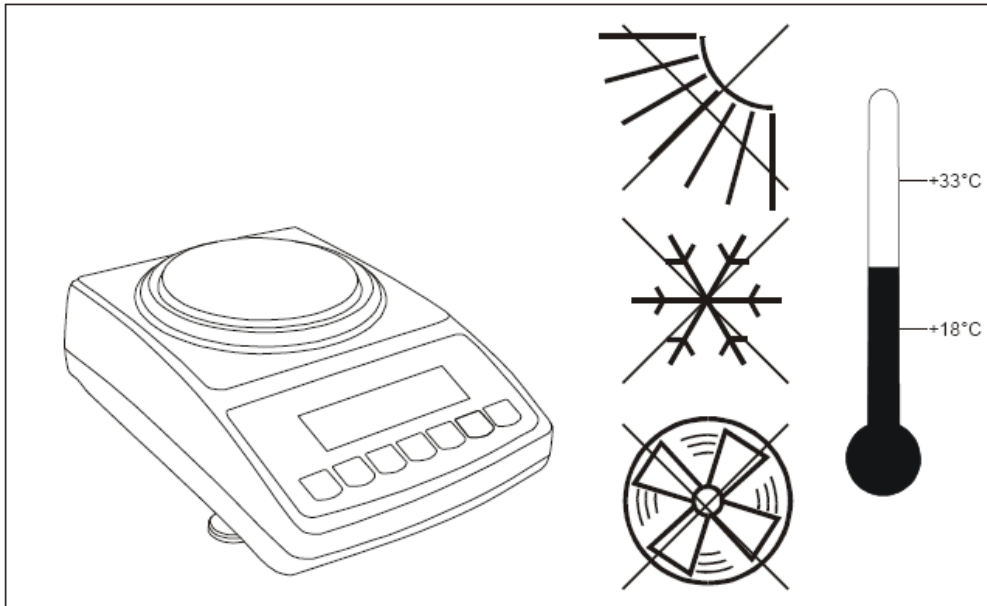
### The optimum location for your scale:



- Stable, vibration-free base as horizontal as possible
- Away from direct sunlight
- Not exposed to high temperature variations
- Away from direct drafts
- The best location is a stable surface away from direct drafts, doors, windows, radiators and air conditioner vents.



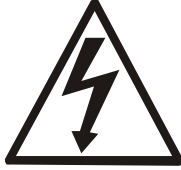
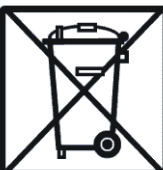

<p><b>CAUTION:</b></p> 	<ul style="list-style-type: none"> <li>• The scale is designed for indoor use only.</li> <li>• Do not operate the scale in hazardous areas or conditions.</li> <li>• Do not use the scale in locations subject to high humidity.</li> <li>• Do not connect cables in ways other than those mentioned in this manual.</li> <li>• Be sure to set the scale on a firm, stable, horizontal surface.</li> <li>• Never stand on or lean upon this product. Equipment may fall or collapse, causing breakage and possible injury.</li> <li>• Before moving the product, unplug it and unplug all cables connected to it.</li> <li>• When storing, transporting or returning the scale for service, always use the original packaging.</li> </ul>
<p><b>WARNING:</b></p> 	<ul style="list-style-type: none"> <li>• Never attempt to repair, disassemble or modify the scale yourself. Tampering with the scale may result in injury and cause more damage to the equipment.</li> <li>• Be sure to use the specified power source.</li> <li>• Do not allow foreign matter to fall into the scale.</li> <li>• If water or other liquid spills into the scale, do not continue to use it. Unplug the power cord immediately and contact technical support.</li> </ul>

**1.1. Important handling Cautions and Warnings**

	<p>Follow all safety guidelines in order to avoid electrical shock, or damage to connected peripheral devices.</p>
<ul style="list-style-type: none"> <li>• All necessary repairs or internal adjustments should be made by authorized personnel only.</li> <li>• To avoid the risk of fire use an outlet of the proper type that provides the specified voltage. The required voltage for the power supply is 115vAC @ 60Hz and requires a minimum of 1.2 amperes of current.</li> <li>• Do not use the scale when the cover is open.</li> <li>• Do not use the scale in explosive atmospheres.</li> <li>• Do not use the scale in very high humidity.</li> <li>• If the scale does not operate properly, unplug the power supply and do not use it until checked by authorized personnel.</li> </ul>	
	<p>Disposal of electronic equipment in waste containers is forbidden by law.</p>
<ul style="list-style-type: none"> <li>• Please dispose of electronic equipment in appropriate recycling centers or by returning to the original point of purchase.</li> </ul>	



Always handle your scale with care. Damage caused by improper handling is not covered under the scale's warranty.

	<p>Never drop or throw any articles onto the scale's pan or onto any other parts of the unit!</p>
	<p>DO NOT let the scale fall or drop from its tabletop surface!</p>
	<p>When moving the scale do not press or apply force onto the scales pan!</p>
	<p>DO NOT pass or handle liquids directly over the scale to avoid spillage and liquid damage!</p>

## Chapter 2: Specifications

	Model	
	BTA210	BTA2100
Capacity	210 g	2000 g
Readability (d)	0.01g	0.1g
Linearity	0.02 g	0.2 g
Stabilization time (typical)	< 3s	
Tare Range	-210 g (Max)	-2000 g (Max)
Pan Dimension	115mm	145mm
Scale Dimension	185 x 290 x 90 mm	
Scale Weight	1 kg	
Power Supply	12VDC@850ma	
Operating Temperature	-18C to +33C	
RS232 Port	Bidirectional	
USB Port	B Type	
Warranty	One Year	

# Chapter 3: Keys, Display Indicators and Abbreviations

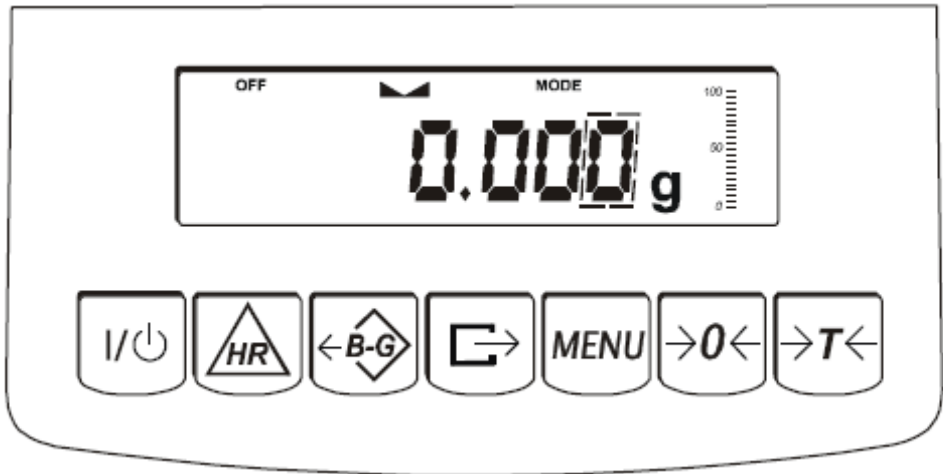

Key	Primary Function
I/O	Power On and Power Off
→T←	Tare – used to tare the weighing pan
→0←	Zero – used to zero the scale (Legal for Trade models only)
MENU	Menu – used to access the main menu
□→	Data Transfer – used to print data or transfer data to a PC via the RS232 communication port
B/G	Gross Weight – used to change display from Net Weight to Gross Weight
HR	High Resolution – temporarily (5 sec) increases the display resolution
Display Indicator	Description
▾	Stability Indicator - The weighing result has stabilized and an accurate reading may be taken.
→0←	Zero - The scale is maintaining a “center of zero” condition. (Legal for Trade models only)
AUT	AZSM (Automatic Zero Setting Mechanism) is enabled. Always enabled in Legal for Trade models.
NET	Net Weight – indicates that the container weight has been removed by tare

# Chapter 4: Parts Description

## BTA Models: Front and Side View

	1	Pan
	2	Pan Support
	3	Draft Ring
	4	LCD Display
	5	Keypad
	6	Leveling Feet
	7	Level Indicator
	8	Draft Shield (Optional)
	9	Draft Shield Top Cover (Optional)

	1	Pan
	2	Pan Base
	4	LCD Display
	5	Keypad
	6	Leveling Feet
	7	Level Indicator

BTA Models: Rear View

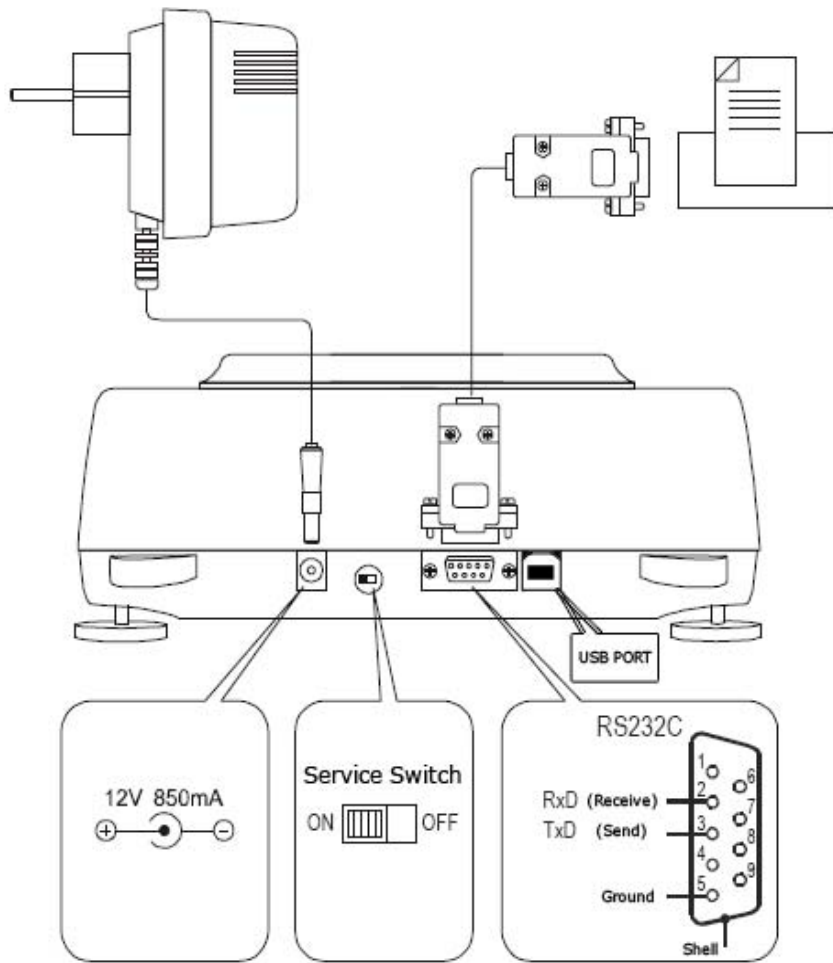



## Chapter 5: Unpacking the Balance and Getting Started

1. Carefully remove the scale, pan, and all of its components out of the packaging. Place them on a stable surface where the scale will not be affected by any mechanical vibrations or high air movements.
2. After removing the pan base and the pan from their packaging, carefully install the pan base (2) onto the scale by seating it on the pan support located in the middle of the scale. Once the pan base has been installed, carefully place the pan (1) on the base
3. Once the pan has been installed, level the scale by adjusting the front feet (6) until the level indicator (7) shows the “air bubble” is in the center position of the sight glass. The level indicator is located on the rear left side of the scale.

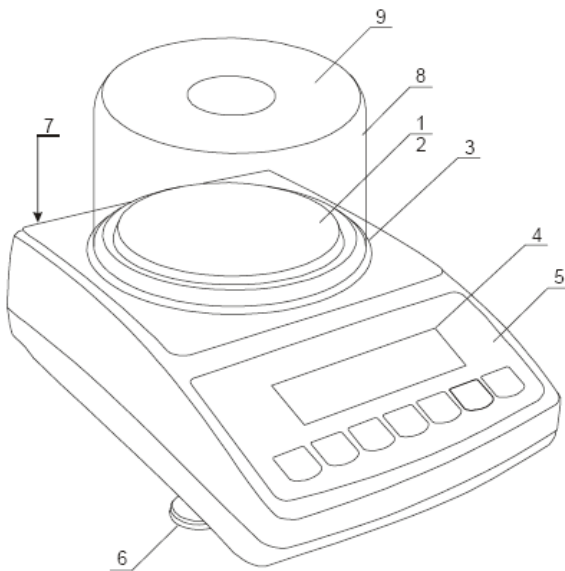

Correct

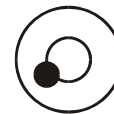

Incorrect

4. After leveling the scale, you may plug the AC adaptor to the AC adaptor socket located in the rear of the scale.

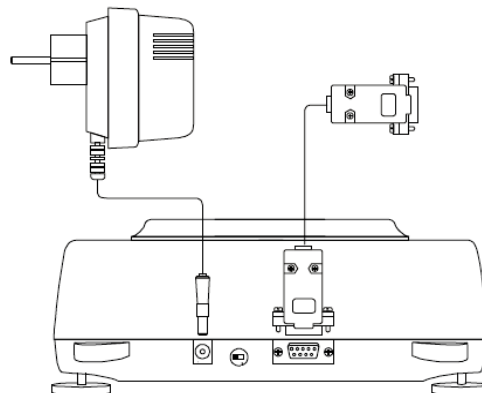

5. When the AC adapter is plugged into the wall outlet, the scale will turn “ON” automatically, initialize itself, and enter weighing mode.



6. To turn the scale OFF press the Power “OFF” button (I/⏻).

## Chapter 6: Basic Principles of Weighing

1. The scale should be properly zeroed before weighing. Proper zeroing is indicated by the Zero Indicator ( $\rightarrow 0 \leftarrow$ ) on the display. If the display signals an out of zero condition (----), press the ( $\rightarrow 0 \leftarrow$ ) key to Zero an empty pan.
2. Weighing allows taring over the entire weight range. This is accomplished by pressing the Tare key, ( $\rightarrow T \leftarrow$ ). Care should be exercised when tare is in use to be sure that the scale's maximum capacity is not overloaded.
3. An accurate weighing result should not be taken until the stability indicator, ( $\blacktriangle \blacktriangleleft$ ), indicates that the result is stable.
4. For best results place the unknown weight in the center of the pan.
5. Always protect the scale from dirt, dust, and corrosive liquids. When Cleaning use of a clean cloth with soap and water, and then dry with a clean wiper.
6. Use the "Active" function to customize the scale's main menu and disable functions that are not used. This makes use the main menu fast and easy.



***Never overload the scale in excess of 20% of the scale's rated maximum capacity.***

## Chapter 7: Battery Installation, Replacement, and Operation



Never enable the “Batter” (bAttErY) function when operating the scale on conventional disposable AA Batteries. The “Battery” function may be enabled only when using rechargeable multi-use batteries.

### Useful Tips for Operating the Scale with a Battery

- In order to increase the battery’s operating life, it is recommended to set the scale’s back light mode to (“back light battery” – B\_LBAT). Refer to Chapter 28 (LCD back light).
- When operating the unit on batteries it is recommended to enable the scale’s “Auto-Off” function by setting it to AUT BAT. This will turn the scale off automatically after 5 minutes of inactivity. Refer to Chapter 29 (Auto Off).

To install or replace the scale’s batteries, follow the steps below:

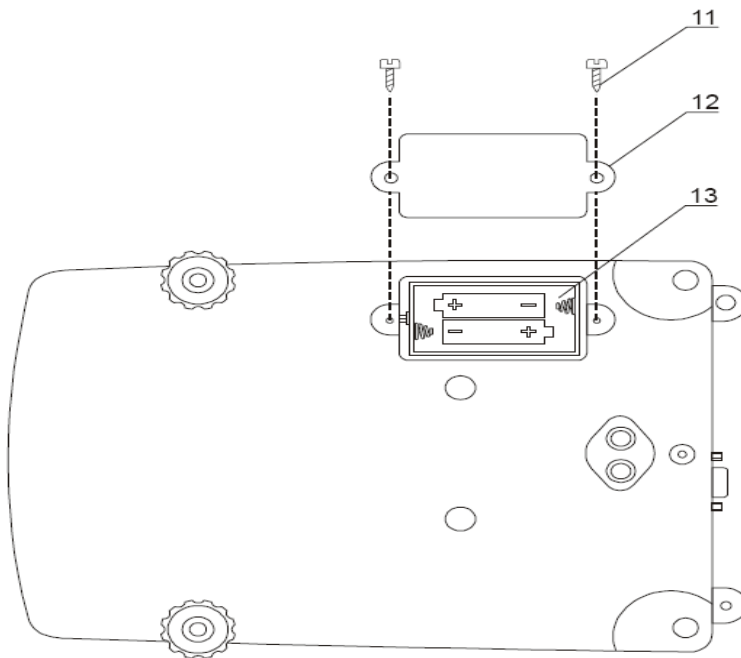



1. Remove the scale’s pan, pan base, as well as the draft ring (BTA210 Models) and carefully place the scale up-side down.
2. Remove the security screws (11) and lift the battery compartment cover (12).
3. Remove the battery nest from the compartment (13).
4. Install four AA batteries. Be sure position the batteries with correct polarity.

## Chapter 8: Functions, Descriptions and Definitions

- **Parts Counting** is used to count parts based on their established average piece weight.
- **Percent weighing** is used to establish the relative weight of an unknown, compared to that of a stored reference weight and expressed as a percent.
- **Recipe Making** is used for weighing and summing individual ingredients such as powders or liquids during recipe making or mixing compounds.
- **Check weighing** is used to check whether a weight of an object falls within specified threshold limits.
- **Animal and dynamic weighing** is used to weigh animals or objects which are in motion while on the pan.
- **Tare Storing** is used to store the values of various containers used for weighing.
- **Filtering** is used to minimize or eliminate the effects of vibrations in the weighing surface.
- **Min / Max Indication** is used in conjunction with Check Weighing to control external indication or sorting equipment.
- **Totalizing** is used for summation of sequential weighing results of items or articles.

## Chapter 9: Weighing

### 9.1 Weighing

1. To begin weighing, press the power button (  ) to turn the scale ON. The scale will go through its initialization procedure and automatically enter “Weighing Mode”. The scale is ready to begin weighing as soon as the stabilization (  ) and zero (  ) indicators appears on the display.

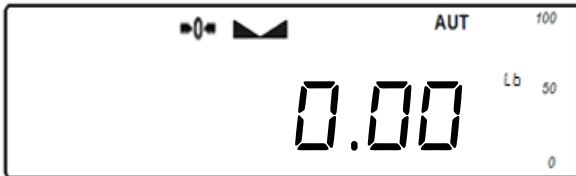

2. When weighing, always place the mass in the middle of the pan. The weighed result may be taken when the stabilization indicator appears on the display.

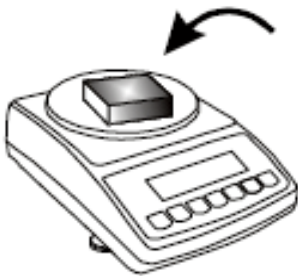

### 9.2 Taring

1. If a container is used for weighing, it may be tared. In taring the container, the scale subtracts the weight of the container from the gross weight to obtain the net weight.
2. To tare the weighing container, place it in the middle of the pan. The container's weight will be shown on the display.



3. Once the stabilization indicator appears on the display, the container is ready to be tared. To tare the container, press the “T” button. The display will show a dotted line which indicates the scale has begun the taring process.



4. When finished taring, the balance will return to weighing and the NET indicator will be lit. The display will indicate 0.00g.

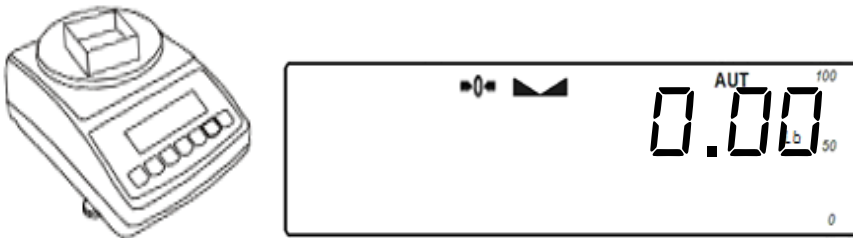

5. Place the unknown weight in the tared container. The NET weight will be displayed.

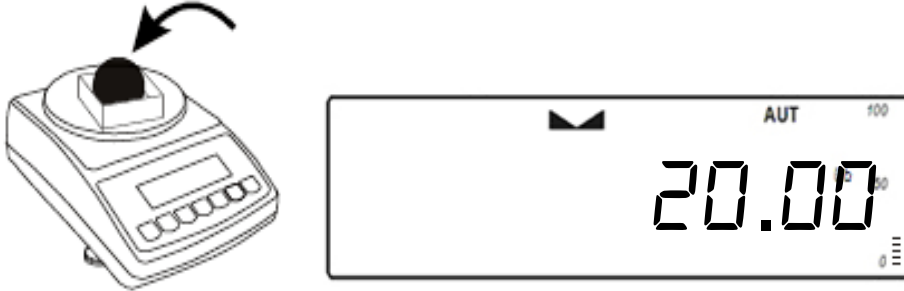

6. To obtain the gross weight (Tared container + unknown weight) press the B/G key.



### 9.3 Extending the resolution

- The resolution of the scale can be temporarily increased by pressing the HR key. This temporary increase in resolution can be very useful in scales where  $d=e$ . The display resolution is increased for 5 seconds and then reverts automatically.



Note: These results are not legal for trade and cannot be sent to a printer or an external computer.

### 9.4 Zeroing the scale

If the display signals are out of zero condition “—”, the scale must be zeroed before weighing.



- To zero the scales press the  $\rightarrow 0 \leftarrow$  key.

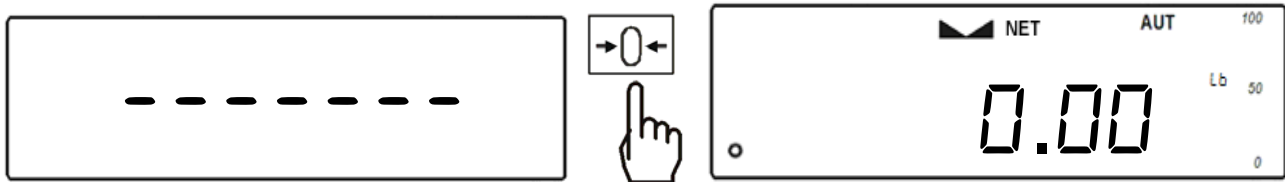



## Chapter 10: Auto-zero (AutotA)

All BA Scales are equipped with AZSM, the “Auto Zero Setting Mechanism.” AZSM automatically maintains a center of zero and 5.0d.

1. Enter the main Menu by pressing the MENU key



2. Select “AutotA” by pressing the T key.

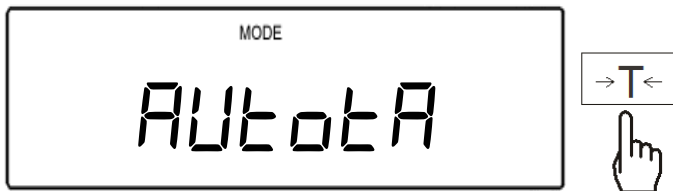

3. To enable Auto-zero press the T key when “Aut on” is displayed, to disable press the T key when “AutoFF” is displayed or select “out” to exit.



## Chapter 11: Parts Counting (PCS)

Functions Options:

PCS Off	(PCS OFF)	Disables Parts Counting
PCS On	(PCS ON)	Enables Parts Counting
PCS ..	(PCS ..)	Recalls the last Average Pieces Weigh used in for counting
PC Set	(PC SET)	Setting a custom sample size
PC UM	(PC UMI)	Setting a custom known Individual Piece Weight
PCS RS	(PCS RS)	obtaining the average piece weight from secondary higher accuracy scale via RS232

### 11.1. Using a default sample size setting

1. Place the counting container on the pan while in the weighing and press the T key to tare the container.

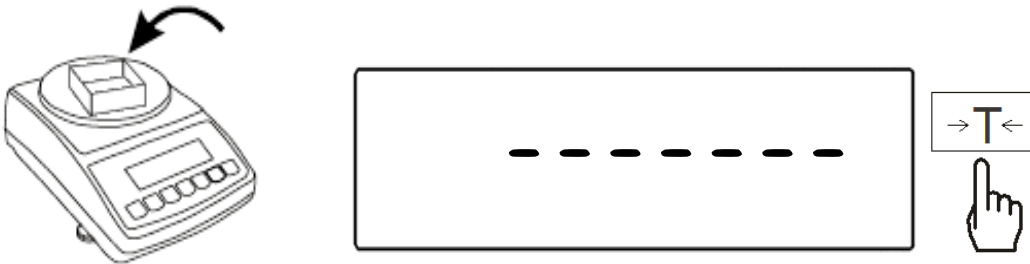

2. Place a sample in the container. The sample size must equal to one of the pre-set options: 5,10,20,50,100, 200,500, and press the MENU key

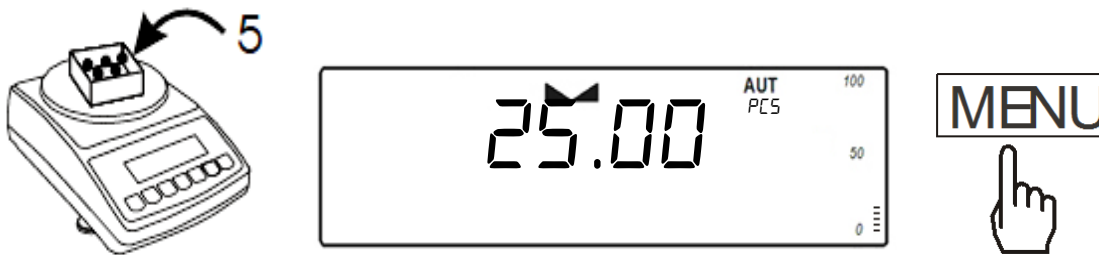

3. Wait for PCS to appear on the display and press the T key



4. Select "PCS on" by pressing the T key.

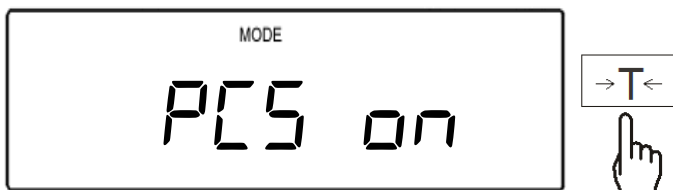

- Available sample size options will alternate on the display. Press the T key to select a size value equal to the number of the sample placed in the container.

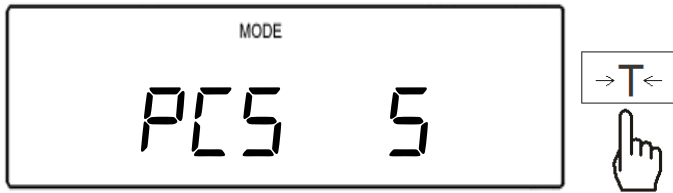

- After the sample size has been selected, the scale will display the count of the sample. At any time you can proceed with the count.

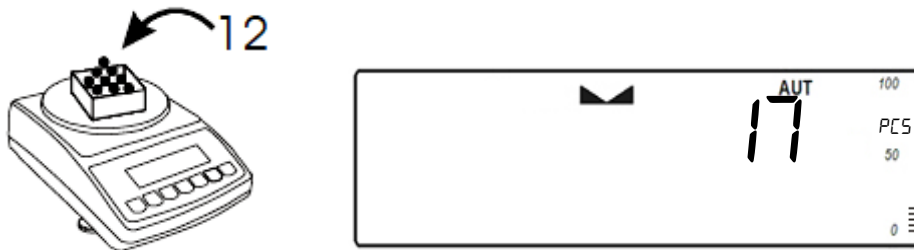

- To turn parts counting off, select PCS from the main menu and press the T key when “PCSoFF” is displayed.

### 11.2 Using a custom sample size

- Place the counting container on the pan while in the weighing mode and press the T key to tare the container.

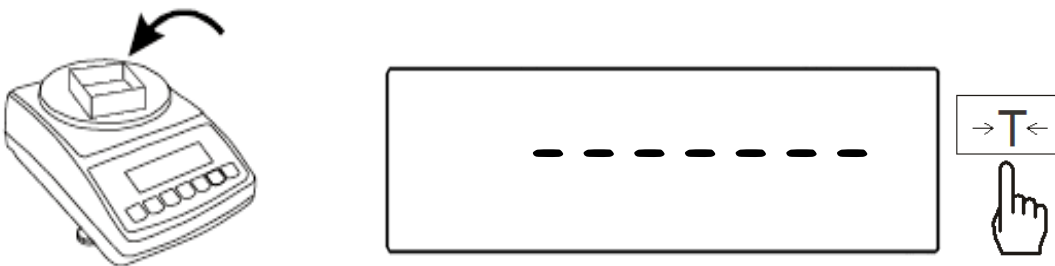

- Place a desired sample size in the container and press the MENU key. (i.e. 12 as illustrated)

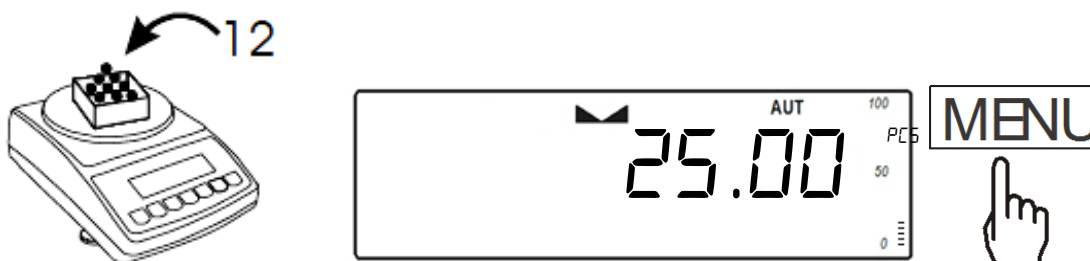

- Wait for PCS to appear on the display and press the T key

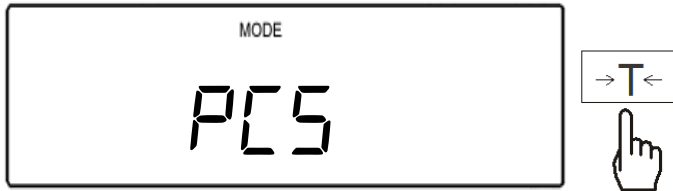

- Select “PCS on” by pressing the T key.

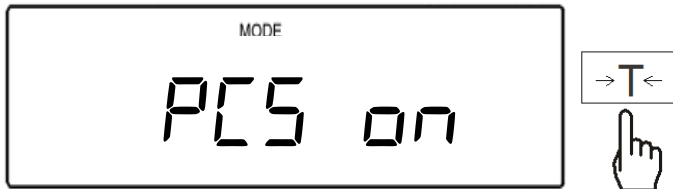

- Available sample size options will alternate on the display. Press the T key when “PC Set” is displayed.

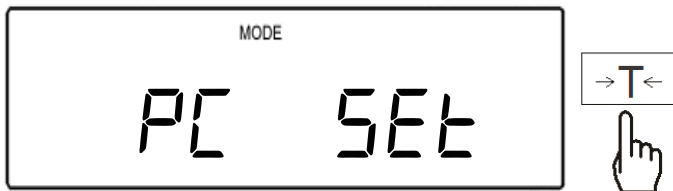

- A dashed line will be displayed indicating to manually enter the value for your sample size in the container. To do so, use the following keys: the →0← key to increment a digit, the →T← key to accept and go to the next digit, and MENU to accept the entire setting.

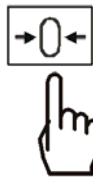

To increment a digit

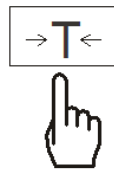

To accept and go to next digit



To accept entered value

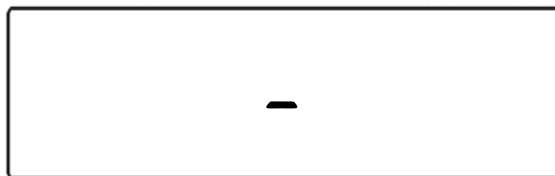

- Once your custom sample size value has been entered and the MENU key pressed, the scale will display the count of the sample. At any time you can proceed with the count.

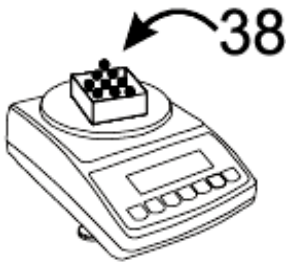

- Once an accurate count has been taken, the container and its contents may be removed from the scale. To Turn parts counting off, select PCS from the main menu and press the T key when PCSoff is displayed.

### 11.3 Counting based on a known Individual Piece Weight (No Sample Size Required)

- Place the counting container on the pan and press the T key to tare the container.

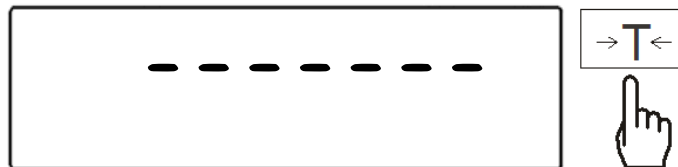

- Press the MENU key to enter the main menu.



- Wait for “PCS” to appear on the display and press the T key



- Select “PCS on” by pressing the T key.

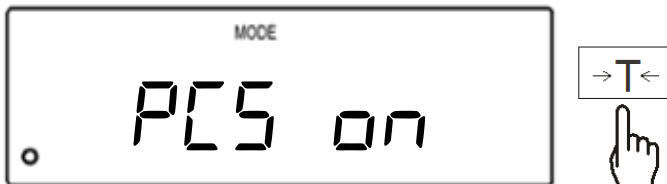

- Available sample size options will alternate on the display. Press the T key when “PC uM” is displayed.

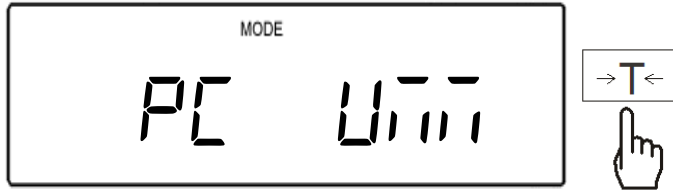

- A dashed line will be displayed indicating to manually enter the exact individual piece weight of the counted parts. To manually enter the individual piece weight, use the following keys: the C key to increment a digit, the T key to accept and go to the next digit, the  $\square \rightarrow$  key to insert a decimal, and the MENU key to accept the entire setting.



To increment a digit

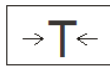

To accept and go to next digit



To insert a decimal



To accept entered value

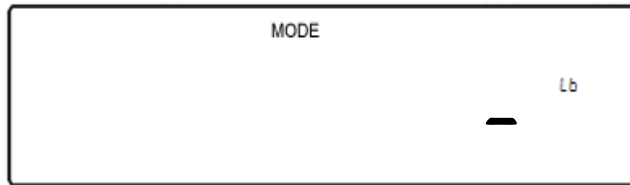

- Once the individual piece weight is entered and the MENU key pressed, the scale will display “0pcs”. At any time proceed with the count.

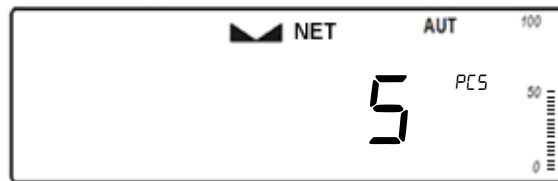
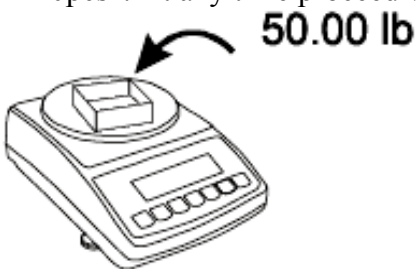

- Once an accurate count has been taken, the container and its contents may be removed from the scale. To exit parts counting and return to basic weighing, select “PCS OFF” from the parts counting menu.

## Chapter 12: Units of measure (Unit)

The BA Scales can operate in nine different units of measure: Grams (g), Kilograms (kg), Carats (ct), Pounds (lb), Newton, Grains, Ounces, Ounces Troy, Pennyweight. By factory default, the scale is set to weigh in grams (lb). To select a different unit of measure, follow the steps below.

1. Enter the main menu by pressing the MENU key.



2. When command “UNITS” is displayed, press the T key.

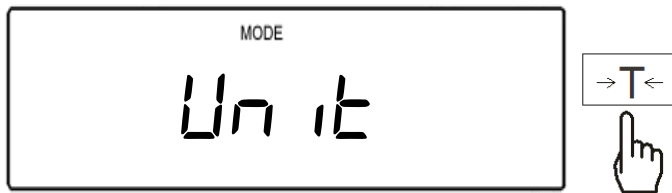

3. The scale will display available units of measure sequentially.

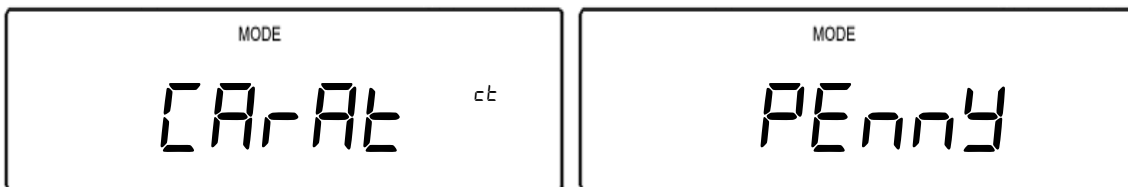

4. When the desired unit is displayed, press the T key to make the selection.



5. Once the selection is made, the scale will automatically return to the weighing mode

## Chapter 13: Percent Weighing (PERC)

Function Options:

- PER Off (PEROFF) Disables Percent Weighing
- PER On (PERON) Enables Percent Weighing

Percent weighing is used to express the weight of an object as a percentage of a stored sample weight. To use percent weighing, follow these steps:

1. Place container on the pan and press the T key to tare.

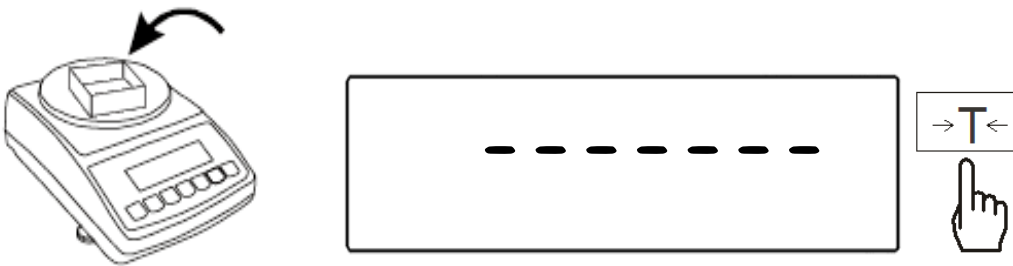

2. Once the scale has been tared, place the sample reference weight on the pan.

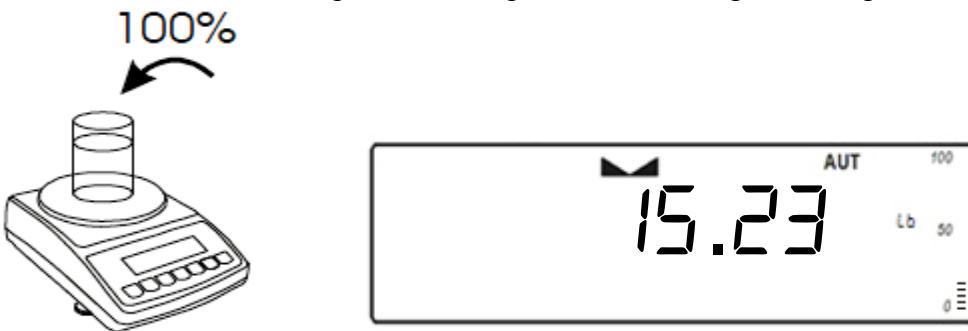

3. The weight of the sample will be displayed as it is placed on the pan. Once the weight of the sample stabilizes and the stability indicator appears on the display, press the MENU key to enter the main menu.

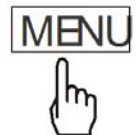

4. When “PERCENT” is displayed, press the T key.

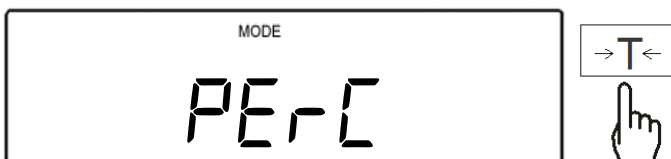



5. Commands “PER OFF” and “PER ON” will be displayed sequentially. To proceed with percent weighing and set the reference sample weight, press the T key when command “PER ON” is displayed.

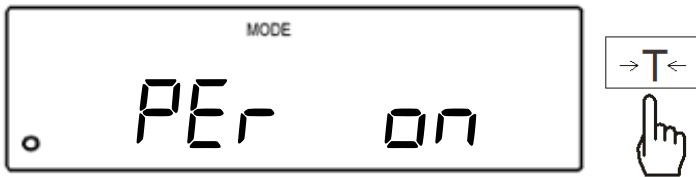

6. Once the reference sample weight is set, the scale will express the weight as a percentage.



7. Remove the sample and place an object in the container. The scale will express the weight of that object as a percentage of the stored sample.

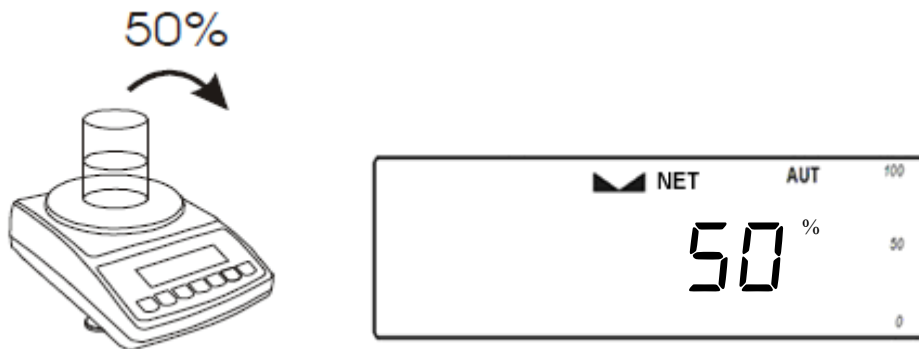

8. To exit percent weighing and return to basic weighing, select “PER OFF” from the percent menu.

## Chapter 14: Recipe Weighing (rEEI PE)

### Function Options:

Rec Off	(rEEoFF)	Disables Recipe Weighing
Rec On	(rEE on)	Enables Recipe Weighing
Rec Con	(rEECon)	allows to continue recipe making after obtaining a total

1. Place the counting container on the pan and press the T key to tare the container.

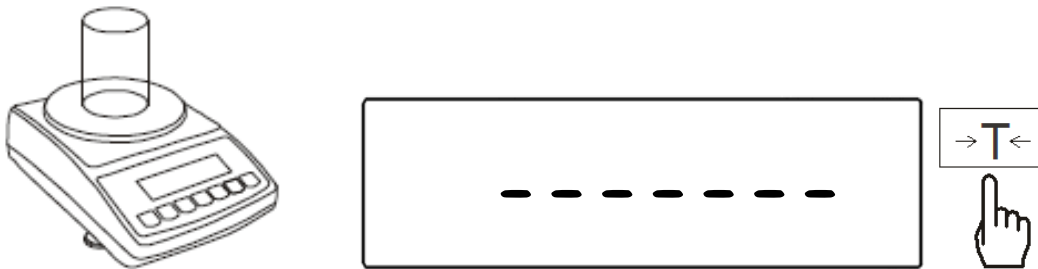

2. Press the MENU key to enter the main menu.

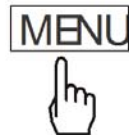

3. Wait for “RECIPE” to appear on the display and press the T key

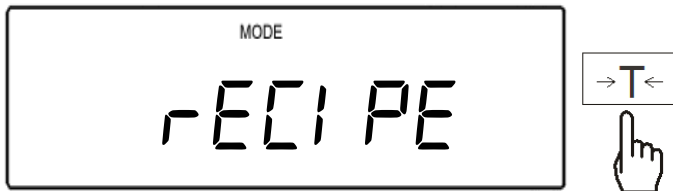

4. Select “Rec on” by pressing the T key.

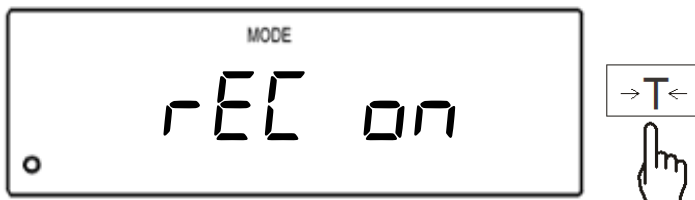

- The display will read 0 indicating that you may place the first ingredient into the container. Once the Weight of the ingredient stabilized press the T key to accept the ingredient weight.

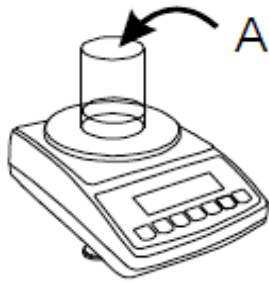

- Once the weight has been accepted place the second ingredient into the container. Once the weight of the second ingredient stabilizes press the T key to accept the ingredient weight.

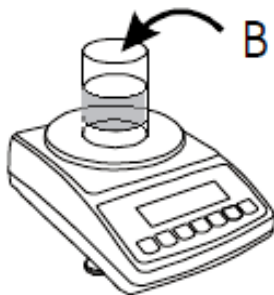

- Steps 1 and 2 can be repeated until all ingredients are in the container. Before obtaining a Total make sure that the last ingredient weight was accepted and the display reads 0.

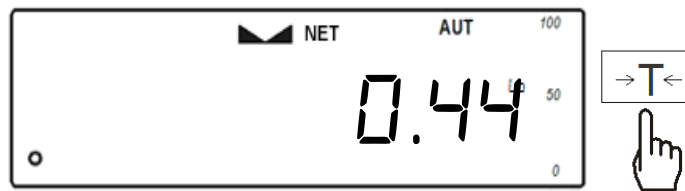
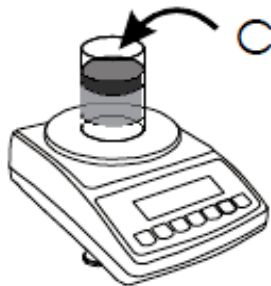

- To obtain the Total for the recipe press the MENU key, select the “Recipe” function, and then select “Rec Off”

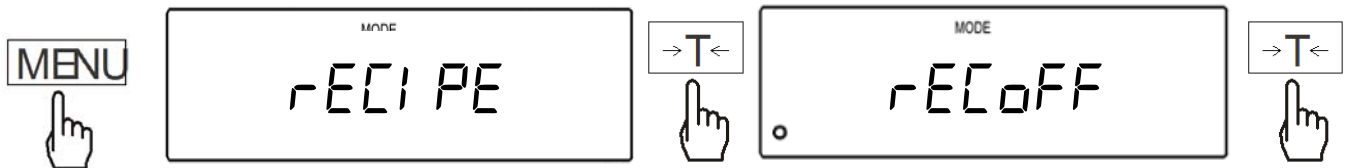

9. The total of all ingredients will be displayed.

A+B+C



10. To continue Recipe making press the Menu select the “Recipe” function, and then select “Rec Con”

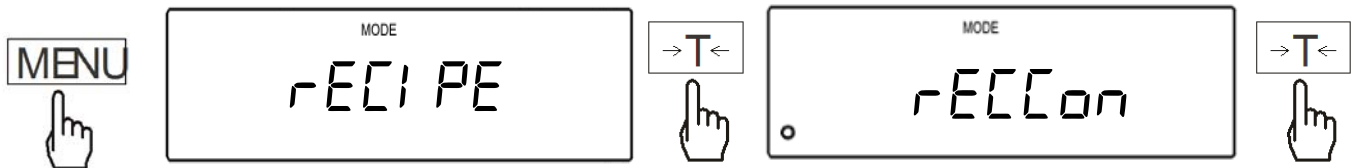

11. Press the T key to accept the current Total and repeat steps 5 through 7 to add more ingredients.
12. To clear and start a new recipe, remove the container and all ingredients from the pan and press the zero key  $\rightarrow 0 \leftarrow$ . Once the result is cleared, repeat steps 1 through 9.

## Chapter 15: Calibration (CALIB)

### Function Options:

CAL On (CAL ON)	Starts Quick Calibration. Recommended when calibrating with a single calibration weight.
CAL Stp (CAL STP)	Starts Stepped Calibration. Recommended when calibrating with multiple calibration weights.
Other (OTHER)	Calibration with calibration mass not equal to the scale's capacity.

Calibration with an external Calibration Weight should be performed if the scale exhibits erroneous readings or periodically to assure accuracy of all weighing results. The scale should be calibrated with a high accuracy weight equal to its maximum capacity. Before starting calibration, have the appropriate calibration weight available.

### 15.1. Quick Calibration (calibrating with a single calibration weight).

1. Press the MENU key, when the option “Calib” is displayed press the T key, and then select the option “CAL On” by press the T key once again.

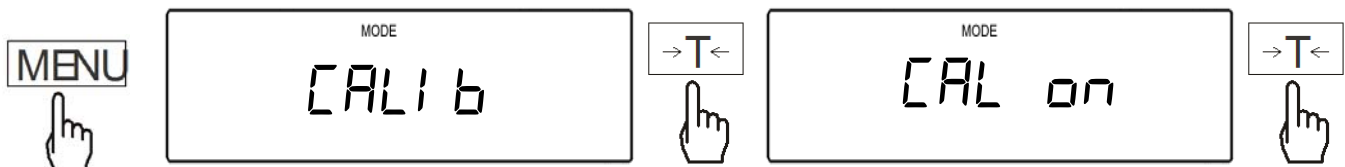

2. The scale will display a full a calibration mass equal to the scales capacity i.e.”30”, and an option to select a different calibration mass”other“. To calibrate the scale with a mass value equal to the scales capacity press the T key when the calibration mass value is displayed (proceed to step 4). To calibrate the scale with a mass lower than the scale’s maximum capacity, press the T when “other” is displayed (proceed to step 3).

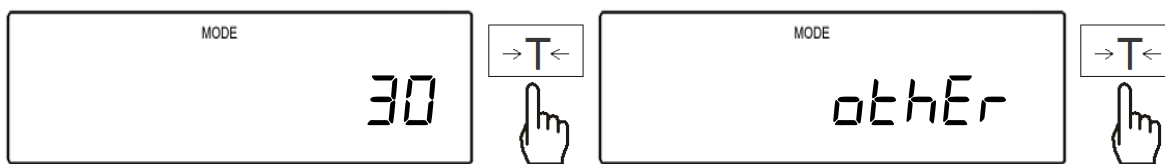

3. If option “other” has been selected a dashed line will be displayed indicating to manually enter the exact value of the calibration mass used to calibrate the scale. To manually enter the calibration value, use the following keys: the C key to increment a digit, the T key to accept and go to the next digit, the  key to insert a decimal, and the MENU key to accept the entire setting.

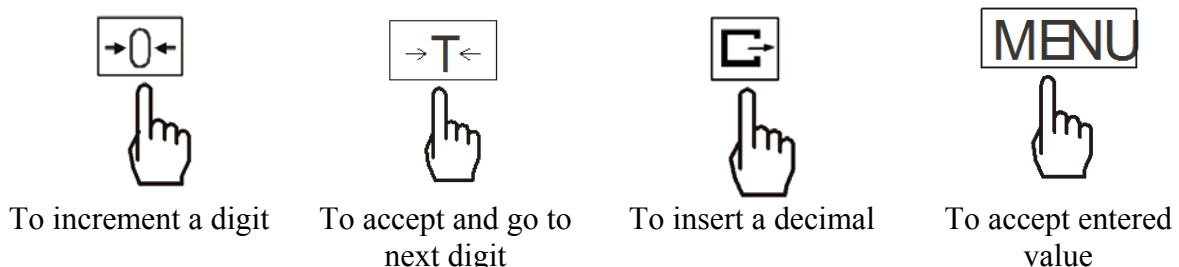

4. The scale will perform a tare and the message “LOAD” will be displayed.

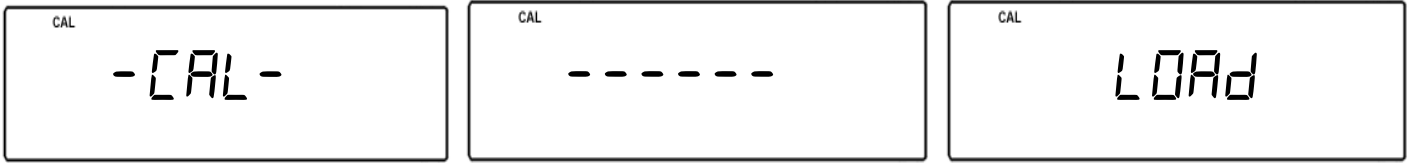

5. When the message “LOAD” is displayed, place the calibration weight on the scale’s hanging pan. Calibration will begin automatically and “WAIT” will be displayed indicating that calibration is in progress.

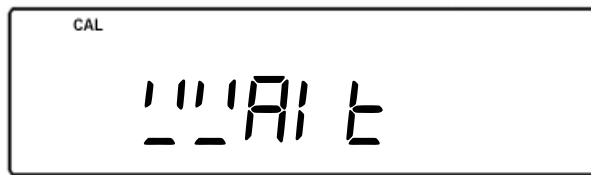
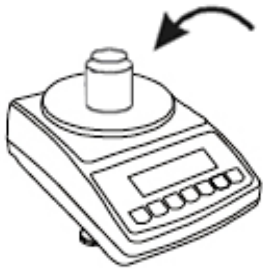

6. When finished the scale will automatically return to the weighing mode, and the calibration weight can be removed from the pan.

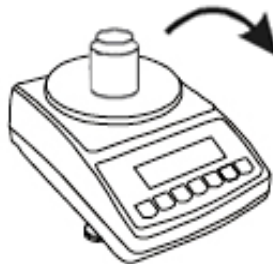

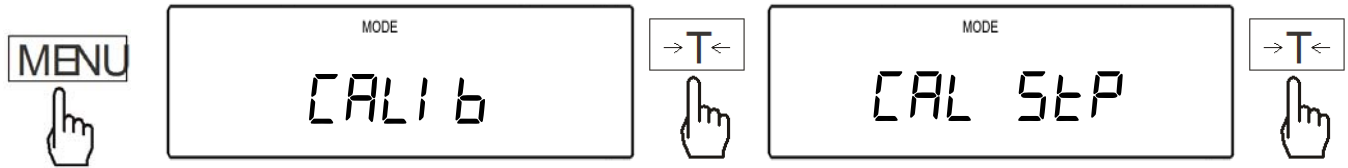

## 15.2. Stepped Calibration (calibrating with multiple calibration weights.)

1. Press the MENU key, when the option “Calib” is displayed press the T key, and then select the option “CAL Stp” by press the T key once again.

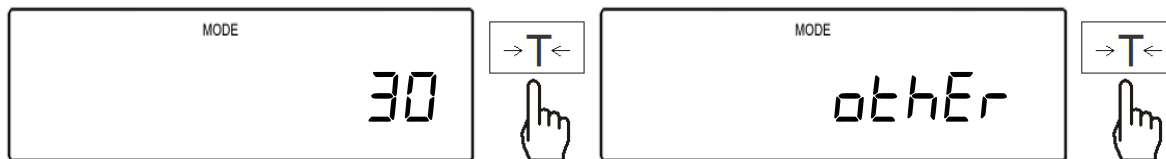

2. The scale will display a full a calibration mass equal to the scales capacity i.e.”30”, and an option to select a different calibration mass”other“. To calibrate the scale with a mass value equal to the scales capacity press the T key when the calibration mass value is displayed (proceed to step 4). To calibrate the scale with a mass lower than the scale’s maximum capacity, press the T when “other” is displayed (proceed to step 3).



3. If option “other” has been selected a dashed line will be displayed indicating to manually enter the exact value of the calibration mass used to calibrate the scale. To manually enter the calibration value, use the following keys: the C key to increment a digit, the T key to accept and go to the next digit, the  key to insert a decimal, and the MENU key to accept the entire setting.

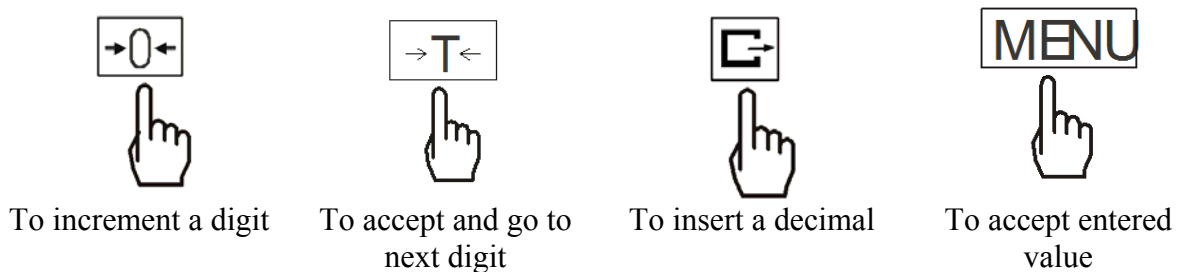

4. The scale will display the message “Press Menu”. When you are ready to Tare the scale Press the MENU key.

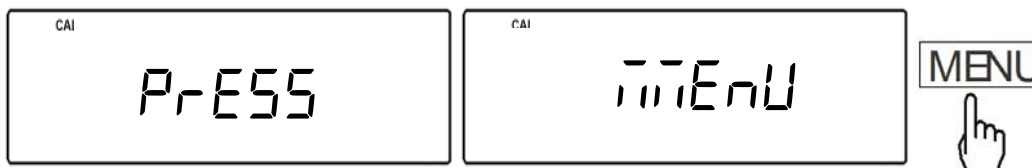

- The scale will perform a tare and the message “LOAD” will be displayed indicating to place all calibration weights on the pan. After placing all weights on the pan, press the Menu key to initiate the calibrations process.

**Caution:** Do not press Menu until all calibration weights are on the scale’s pan

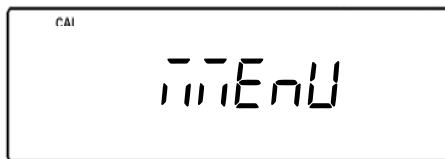
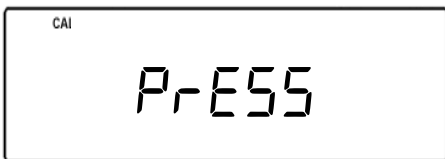
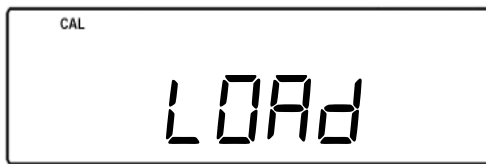
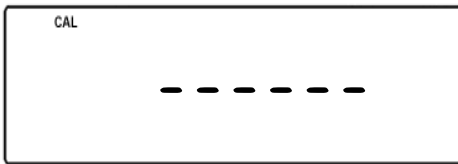
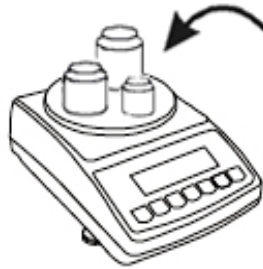

- Message “CCCCCC” will be displayed indicating that calibration is in progress. When finished the scale will automatically return to the weighing mode and the calibration weights can be removed from the pan.

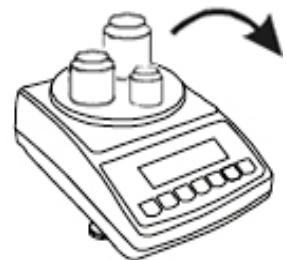
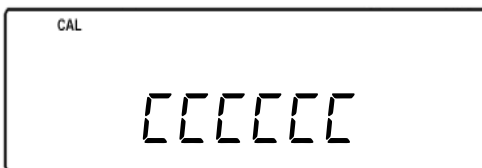



## Chapter 16: Port 1 - RS232 Communication Port Configuration (Port 1)

After a weighing transaction is completed, a result data receipt can be printed. To initiate printing, press the data transfer key. Data may be sent to a printer or a PC via the Torbal Communication Software.



### 16.1. Data Transmission and Exchange Protocol

#### Data Transmission (LONG):

Transmission Parameters: 8 bits, 1 stop bit, no parity, baud rate 4800bps,

#### Exchange data:

- Transmit the weight (equivalent to the Print Key, , in weighing):  
 Computer→Scale: **S I CR LF** (53h 49h 0Dh 0Ah) – initiating signal,  
 Scale→Computer: scale sends 16 Bytes of data as follows:
 

Byte	1	- The charater ‘-’ or space
Byte	2	- space
Bytes	3,4	- digit or space
Bytes	5-9	- digit, comma, or space
Byte	10	- digit
Byte	11	- space
Byte	12	- k, l, c, p or space (for kg,lb,ct,pc, or%)
Byte	13	- g, b, t, c or %
Byte	14	- space
Byte	15	- CR
Byte	16	- LF
- ‘Tare the weight’ (corresponds to the →T← key in weighing):  
 Computer→Scale: **S T CR LF** (53h 54h 0Dh 0Ah),  
 Scale→Computer: no response.
- ‘Zero the scale’ (corresponds to the key →0← in weighing):  
 Computer→Scale: **S Z CR LF** (53h 5Ah 0Dh 0Ah),  
 Scale→Computer: no reponse.
- ‘Turn On / Off the Scale (corresponds to the key I/⏻ in weighing):  
 Computer→Scale: **S S CR LF** (53h 53h 0Dh 0Ah),  
 Scale→Computer: no response.
- ‘Display the MENU’ (corresponds to the key *MENU* in weighing):  
 Computer→Scale: **S F CR LF** (53h 46h 0Dh 0Ah),  
 Scale→Computer: no response.

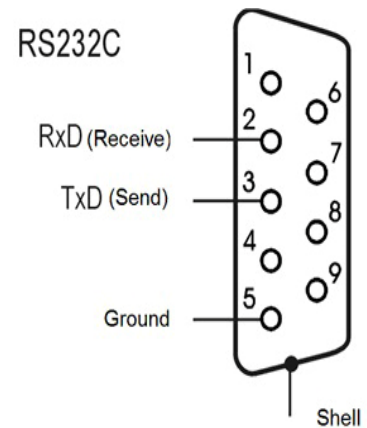

- Setting the threshold 1 (optional):  
 Computer→Scale: **S L** *DI...DN* CR LF (53h 4Ch *DI...DN* 0Dh 0Ah)  
 where: *DI...DN* – Threshold value, up to 8 characters,  
 Scale→Computer: no response,
- Example:  
 To set 1000g in weight B1.5 (d=0.5g) type:  
 S L 1 0 0 0 . 0 CR LF (53h 4Ch 31h 30h 30h 30h 2Eh 30h 0Dh 0Ah).  
 To set 100kg in weight B150 (d=50g) type:  
 S L 1 0 0 . 0 0 CR LF (53h 4Ch 31h 30h 30h 2Eh 30h 30h 0Dh 0Ah),
- Setting the threshold 2 (optional):  
 Computer→Scale: **S H** *DI...DN* CR LF (53h 48h *DI...DN* 0Dh 0Ah),  
 where: *DI...DN* – threshold value, up to 8 characters,  
 Scale→Computer: no response

### Cable WK-1 Configuration

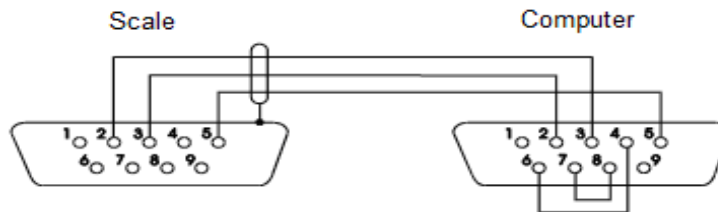

### Cable WD-1 Configuration

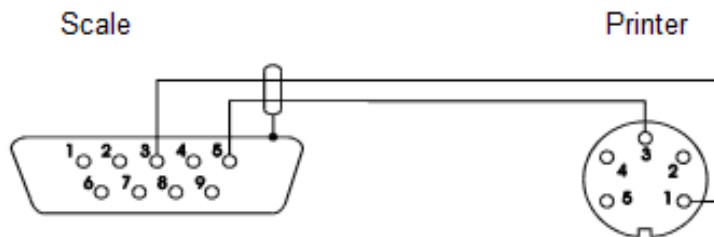

### 16.2. Baud Rate

1. Press the MENU key, when the option “Port - 1” is displayed press the T key, and then select the option “Baud” by press the T key once again.

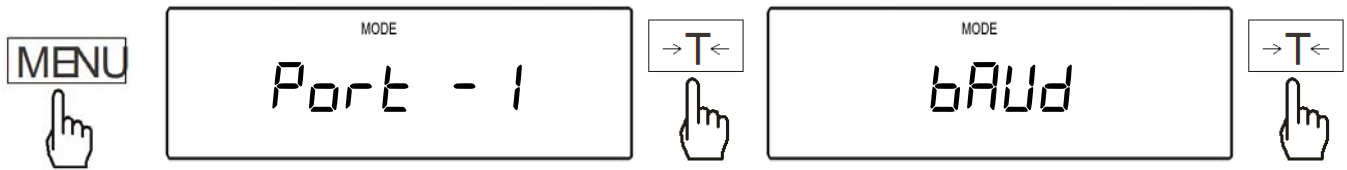

2. The scale will begin to display available baud rates: “4800”, “9600”, “19200”, “38400”, and “57600”. To make a selection, press the T key when the desired setting is displayed.

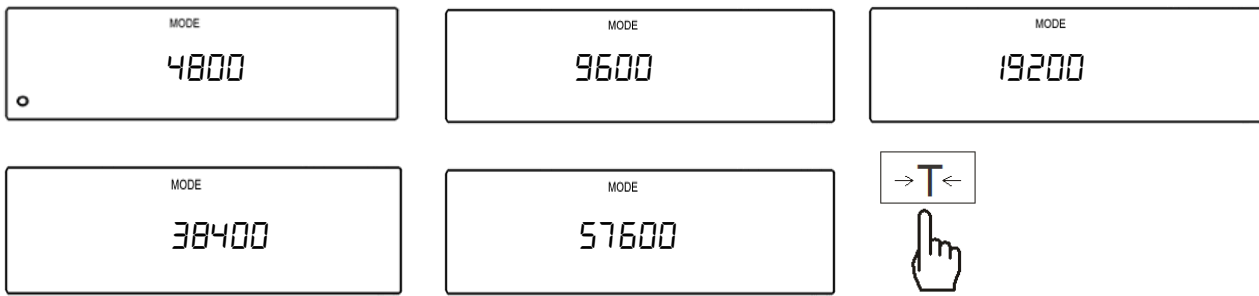

### 16.3. Bites

1. Press the MENU key, when the option “Port - 1” is displayed press the T key, and then select the option “Bites” by press the T key once again.

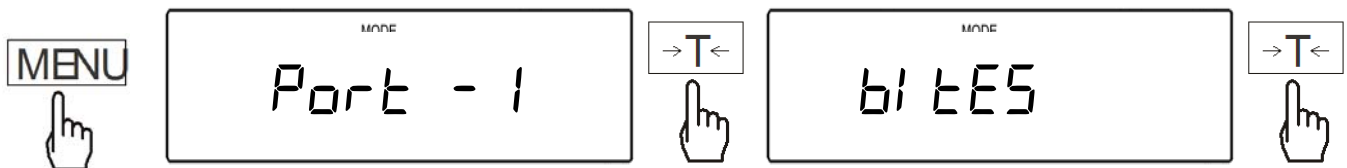

2. The scale will display available Bits settings: “7-bit”,”8-bit”. To make a selection press the T key when the desired setting is displayed.

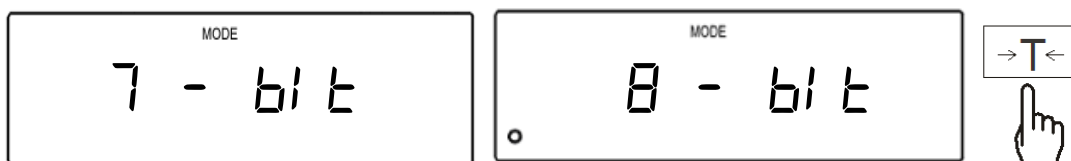

## 16.4. Parity

1. Press the MENU key, when the option “Port - 1” is displayed press the T key, and then select the option “Parity” by press the T key once again.

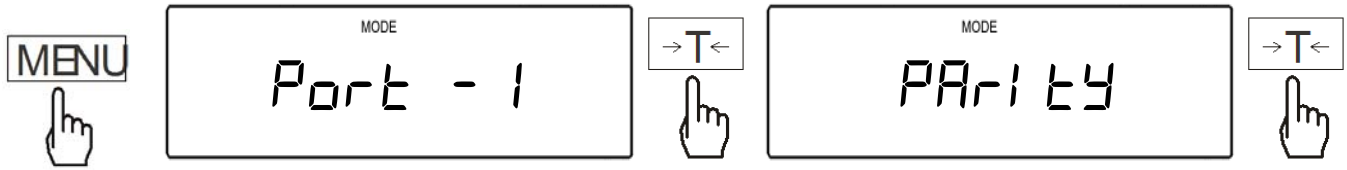

2. The scale will display available Parity settings: “none”, ”odd”, “even”. To make a selection press the T key when the desired setting is displayed.



## Chapter 17: Port 2 – USB Configuration (Port 2)

Before connecting the scale to a computer the USB Port must be configured with the appropriate baud rate and other necessary parameters. To configure the USB Port follow configuration steps from **Chapter 15** and apply them to menu option “Port-2.”

### PC Connection via USB

Once the USB port has been configured, connect the scale to the PC with a Standard A/B USB cable and follow the “Found New Hardware” configuration wizard as described below.

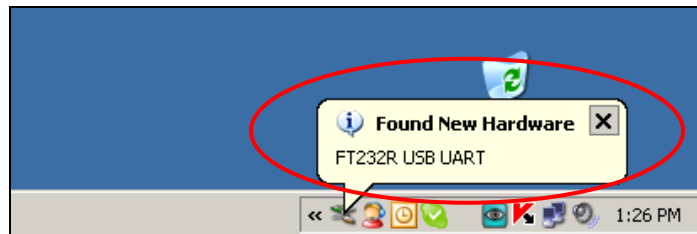

1. Allow Windows to connect to Windows Update in order to search for software. Select “*Yes, this time only*” and click “Next”. Once driver “FT232R USB UART” has been found, select “*Install the software automatically (Recommended)*” and click “Next”.

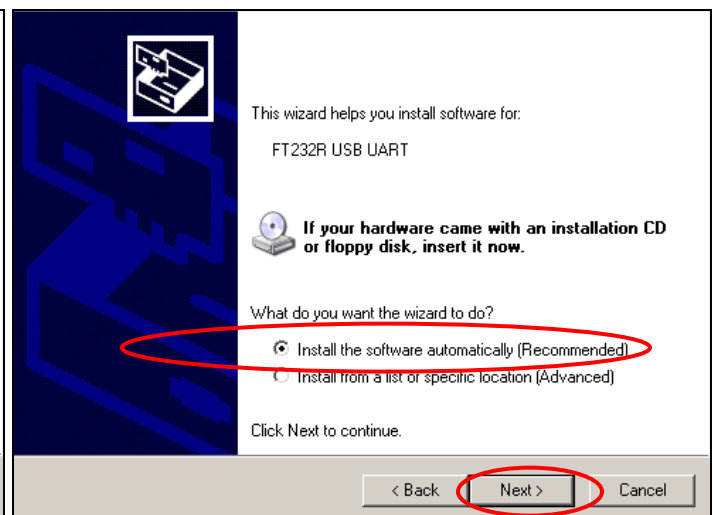
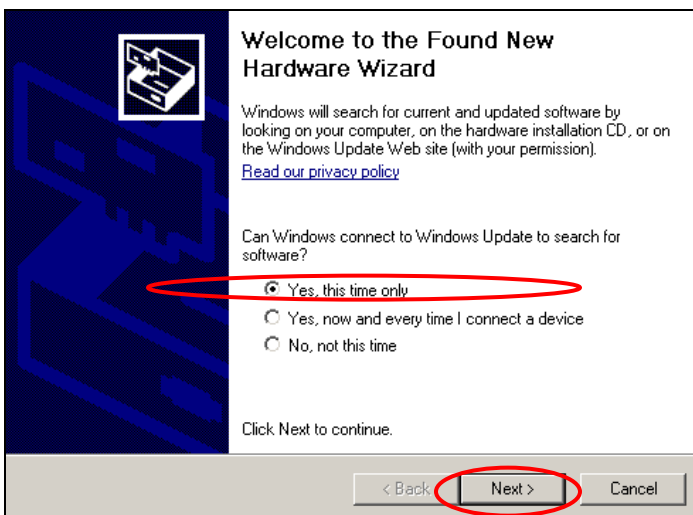

- Windows will begin installation of the driver, when completed click “Finish”.

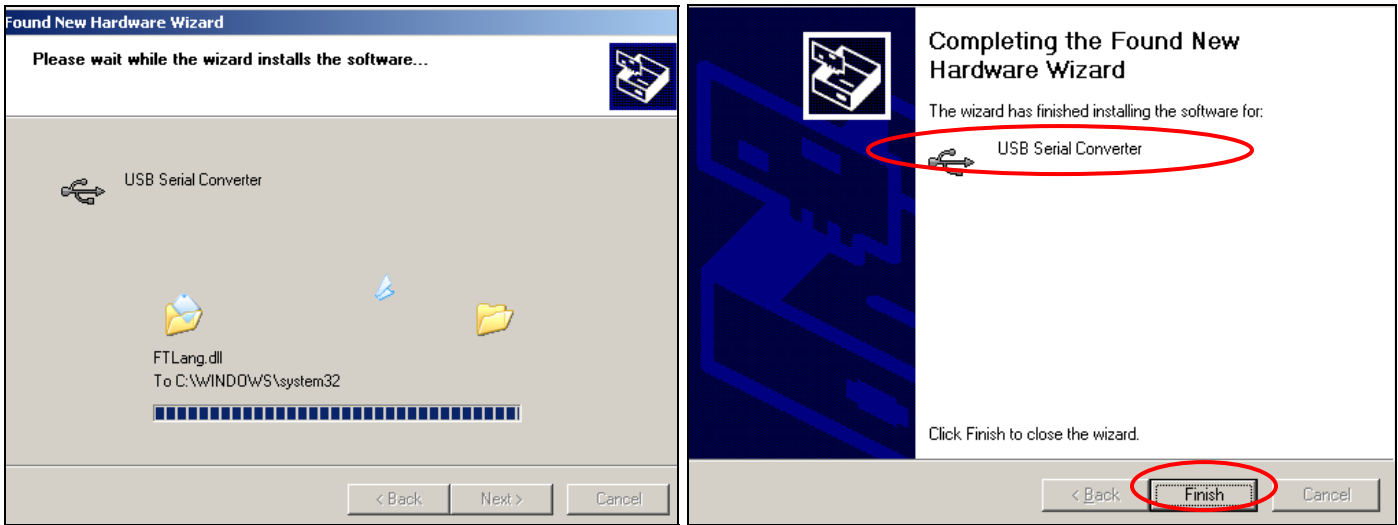

- Once installation of the driver has been completed the scale is ready to communicate with the PC via the USB port.

## Chapter 18: Receipt Printout (Print)

A detailed transaction receipt can be printed after weighing has been completed. The receipt can be customized to include the following information:

<div style="border: 1px solid black; padding: 5px; text-align: center;"> <small>MODE</small>            HEAdEr         </div>	<b>Header</b> – includes unit information such as: Mode number, Max Capacity, resolution and Unit Serial number.
<div style="border: 1px solid black; padding: 5px; text-align: center;"> <small>MODE</small>            IdOPER         </div>	<b>Operator Id</b> – shows the ID number of the user which performed the weighing transaction
<div style="border: 1px solid black; padding: 5px; text-align: center;"> <small>MODE</small>            dAtE         </div>	<b>Date</b> – Date of the performed transaction
<div style="border: 1px solid black; padding: 5px; text-align: center;"> <small>MODE</small>            tImE         </div>	<b>Time</b> – Time at which the transaction was performed
<div style="border: 1px solid black; padding: 5px; text-align: center;"> <small>MODE</small>            Prn no         </div>	<b>Printout number</b> – Number of the receipt printed in a given day
<div style="border: 1px solid black; padding: 5px; text-align: center;"> <small>MODE</small>            Id Prod         </div>	<b>Product Id</b> – ID number of the product or item weighed
<div style="border: 1px solid black; padding: 5px; text-align: center;"> <small>MODE</small>            CoUnt         </div>	<b>Count</b> – Result obtained in Parts Counting
<div style="border: 1px solid black; padding: 5px; text-align: center;"> <small>MODE</small>            APW         </div>	<b>APW</b> – Average Piece weight of the counted parts in the Parts Counting Functions
<div style="border: 1px solid black; padding: 5px; text-align: center;"> <small>MODE</small>            nEtto         </div>	<b>Net</b> – Net result of the weighing transaction
<div style="border: 1px solid black; padding: 5px; text-align: center;"> <small>MODE</small>            tArE         </div>	<b>Tare</b> – tared weight in the weighing transaction
<div style="border: 1px solid black; padding: 5px; text-align: center;"> <small>MODE</small>            brUtto         </div>	<b>Gross</b> – gross weight of the weighing transaction
<div style="border: 1px solid black; padding: 5px; text-align: center;"> <small>MODE</small>            totAL         </div>	<b>Total</b> – grand total obtained in the totalizing function

### 18.1. Enabling and Disabling Receipt Fields

1. Press the MENU key, when the option “Print” is displayed press the T key, and then select a desired field by press the T key once again when the name is displayed.

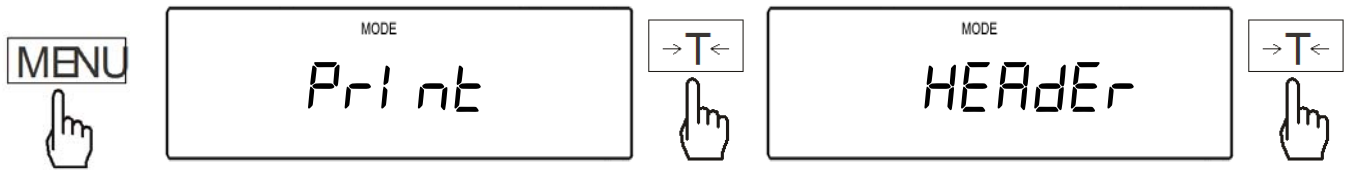

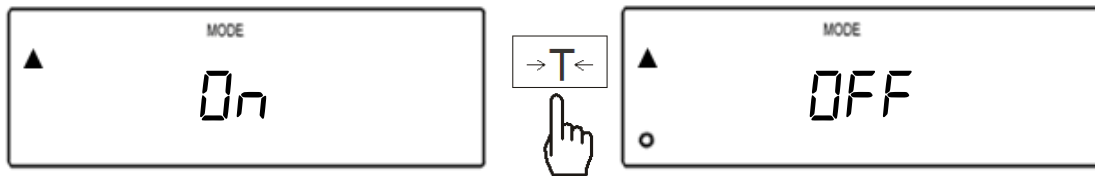

2. The scale will display options “ON” and” Off”. To enable the field press the T key when “On” displayed, to disable the field press the T key when “Off” is displayed.

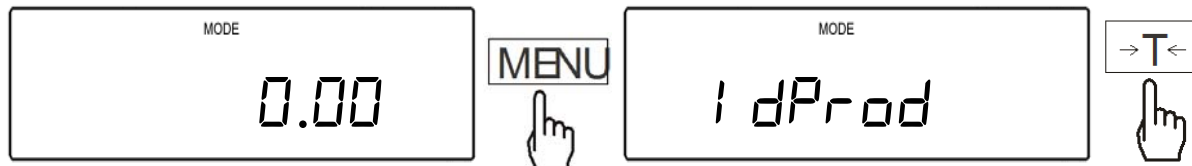

### 18.2. Assigning Operator and Product ID numbers.

1. From the weighing mode press and hold the Menu key for 3 seconds or until the scales displays “IDPROD” and “IOPER”. Select the desired option by pressing the T key.



2. A dashed line will be displayed indicating to manually enter ID number. To manually enter the ID number, use the following keys: the C key to increment a digit, the T key to accept and go to the next digit, the  key to insert a decimal, and the MENU key to accept the entire setting.

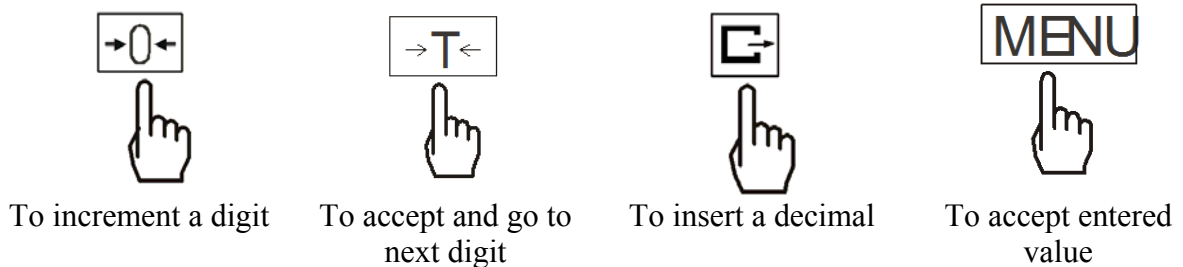



## Chapter 19: Dynamic and Animal Weighing (LOC)

Function Options:

- LOC Off (LOC OFF) Disables the LOC Dynamic Weighing Function
- LOC On (LOC ON) Enables and Starts the LOC Dynamic Weighing Function (Weight integration initiates automatically)
- LOC Prn (LOC Prn) - Enables and Starts the LOC Dynamic Weighing Function (Weight integration is initiated manually with the press of the Data Transfer Key )

1. Place a container on the pan and press the T key to tare.

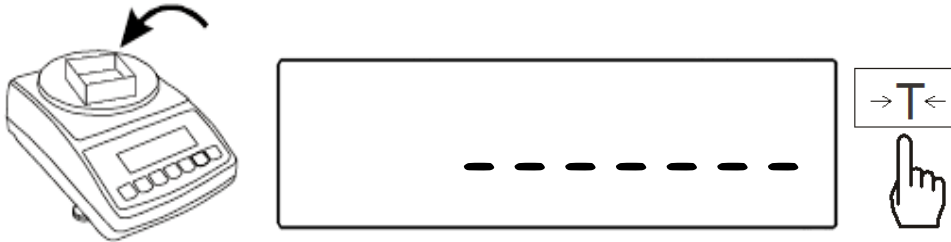

2. Press the Menu key, when the option “LOC” is displayed press the T key, and then select the option “LOC On” or “LOC Prn” by press the T key once again.

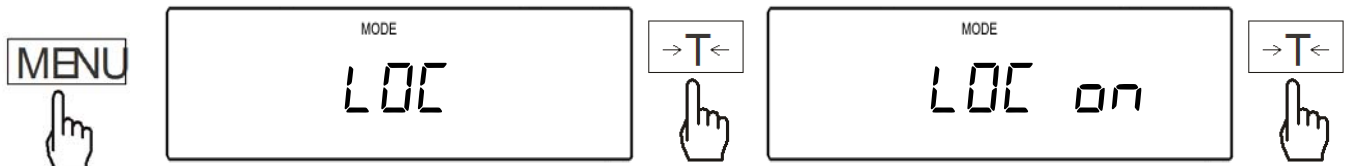

3. Place the animal or the moving object on the pan. Weight integration will begin automatically. If “LOC Prn” was selected press the data transfer key . While the scale is integrating the weighing result the display flashes.

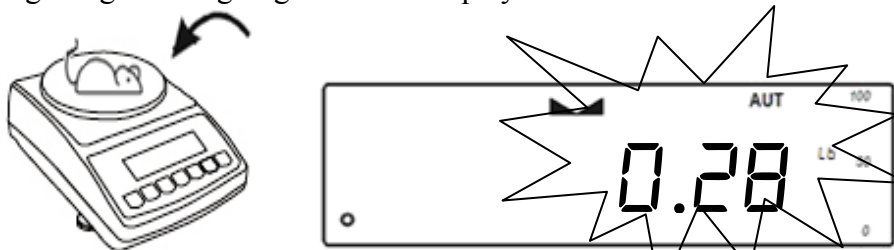

4. Final result will be automatically sent to a printer or a PC via the RS232 port. During data transmission the word print will be displayed. The final result remains displayed for 30 seconds. To perform the next weighing remove the animal, wait for the scale to display 0 and place the next animal on the pan.

## Chapter 20: Storing Tare Values

### 20.1. Storing a Tare Value Manually

1. Press the MENU key, when the option “Tare” is displayed press the T key, and then select the option “Tar Set ” by press the T key once again.

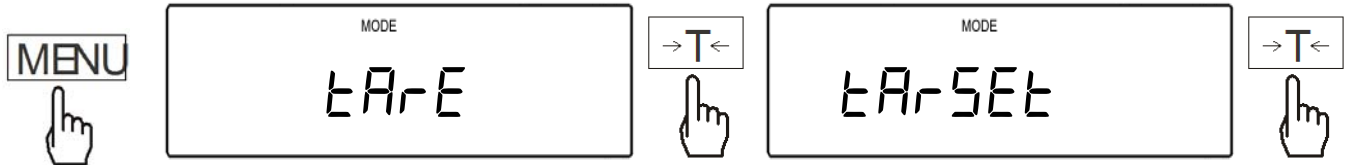

2. The scale will begin to Display tare locations. Locations marked with a dot in the upper left corner of the LED have a stored tare value assigned. To select a tare location or overwrite a current location press the T key when a desired location is displayed, and then select the option “Manual ” by press the T key once again.

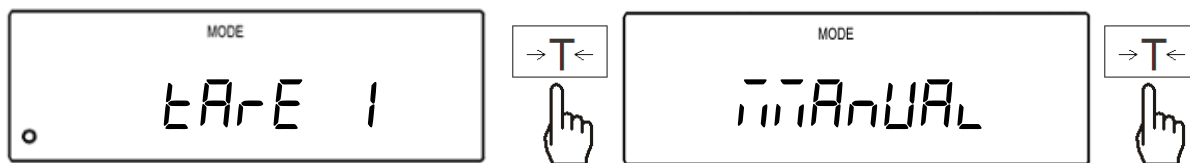

3. A dashed line will be displayed indicating to manually enter the Tare value. To manually enter tare value, use the following keys: the C key to increment a digit, the T key to accept and go to the next digit, the  key to insert a decimal, and the MENU key to accept the entire setting.

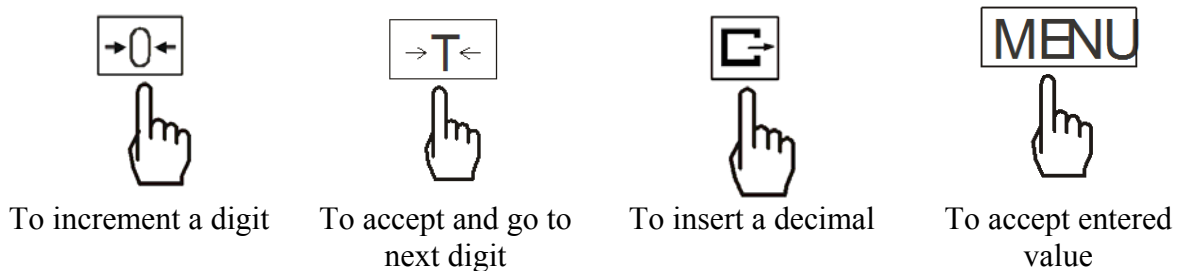

4. Once a tare value has been assigned, the scale will automatically store the value in the selected memory location and return to the weighing mode with the tare value in use.

20.2. Storing a Tare Value Automatically

1. Place a container on the pan and press the MENU key to enter the main menu.

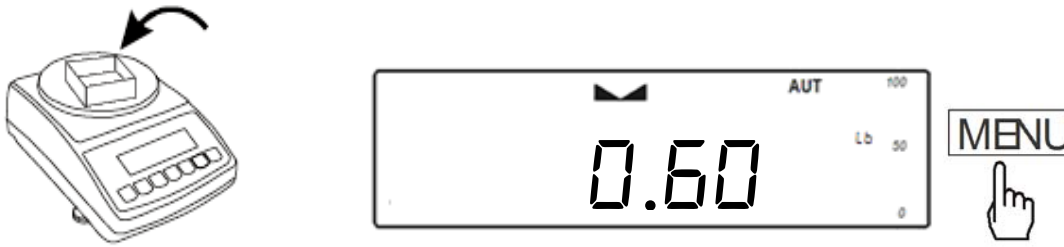

2. When the option “Tare” is displayed press the T key, and then select the option “Tar Set ” by pressing the T key once again.

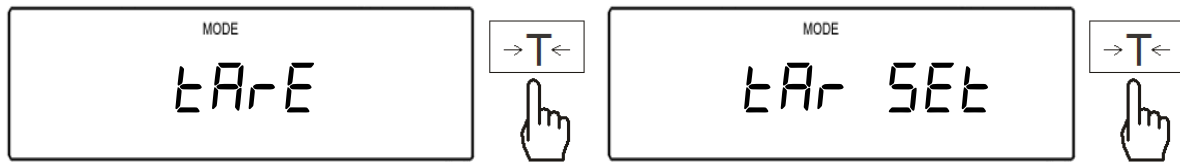

3. The scale will begin to Display tare locations. Locations marked with a dot in the upper left corner of the LED have a stored tare value assigned. To select a tare location or overwrite a current location press the T key when a desired location is displayed, and then select the option “Pan ” by press the T key once again.

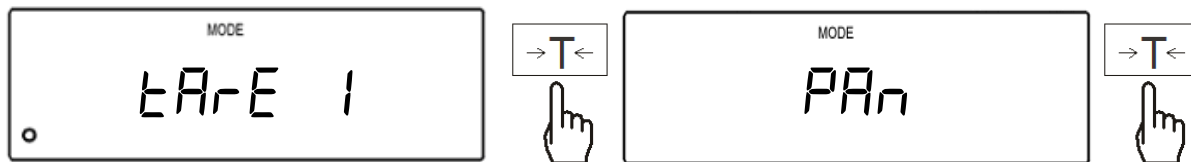

4. The scale will automatically store the value of the container on the in the selected memory location and return to the weighing mode with the tare value in use.

### 20.3. Recalling a previously stored tare value.

1. Press the Menu key, when the option “Tare” is displayed press the T key, and then select the option “Tar On” by press the T key once again.

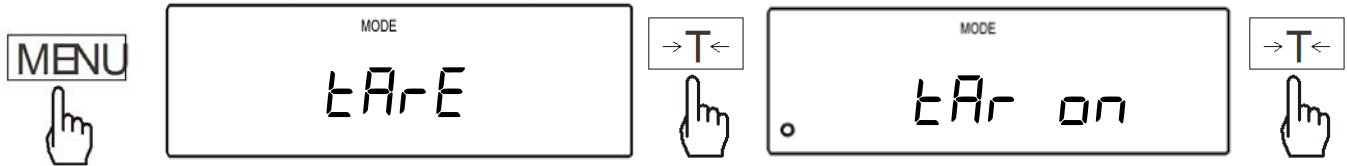

2. The scale will begin to Display tare locations. Locations marked with a dot in the upper left corner of the LED have a stored tare value assigned. To select a tare location press the T key when a desired location is displayed.

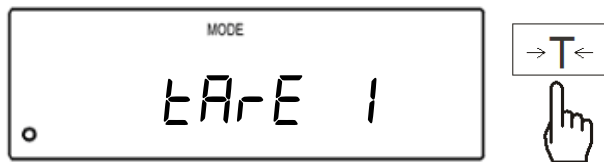

3. The scale will return to the weighing mode with the selected tare value in use.

## Chapter 21: Min – Max Weighing (UP)

This function allows you to find the maximum (highest) or minimum (lowest) weight in a series of weights.

1. Press the MENU key, when the option “Up” is displayed press the T key, and then select the option “High” or “Low” by press the T key once again.

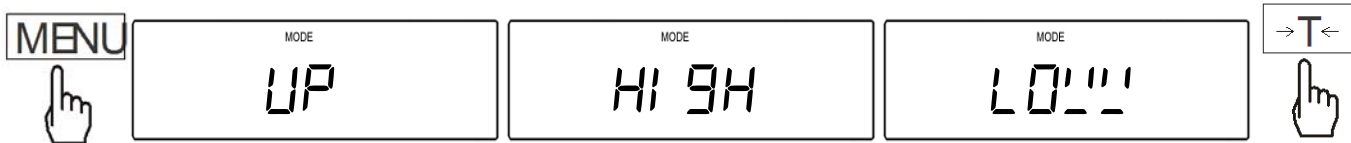

2. The scale will return to weighing and it will begin to hold on the display the highest or the lowest weight. When seeking the highest weight in a series make sure to remove the previous weight from the pan before adding the new weight. When seeking the lowest value weight be sure to add the new weight before removing the previous weight.

**Note:** Add and remove weights with care in order not to increase the weight unintentionally.

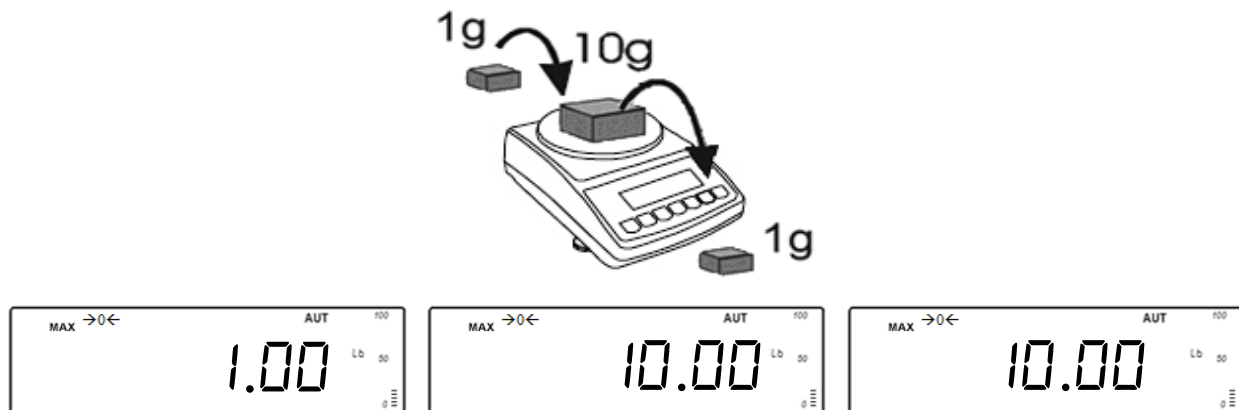

**Note:** Stability indicator and Auto-Zero is disabled during Min/Max weighing.

## Chapter 22: Newton – Force Measurement (nE'""t0)

This function changes the unit of weight to Newton (N) -  $1N \approx 0.101971 \text{ kg}$

1. Press the Menu key, when the option “Newton” is displayed press the T key.

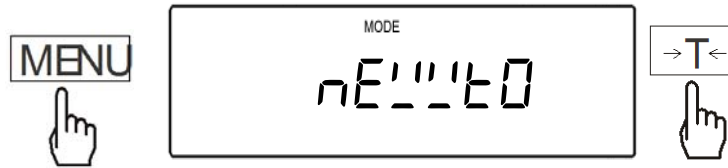

2. The scale will display options “ON” and” Off”. To enable Newton force measuring press the T key when “New On” displayed, to disable Newton force measuring press the T key when “New Off” is displayed.



## Chapter 23: Filtering (FIlLtEr)

This function is used when vibration is encountered during weighing. This may be the result of ground vibration, or a vibrating live load on the pan. Increasing the filter setting will increase the time required for a measurement. The integration time of the measurement is increased thereby eliminating higher frequency vibration.

1. Press the MENU key, when the option “Filter” is displayed press the T key.

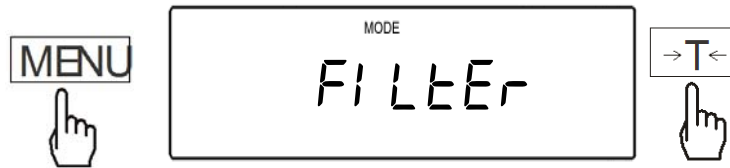

2. The scale will display options “Off” and available filter sensitivity levels “Fil 10, Fil 20, Fil 30 and Fil 40”. To select and enable Filtering press the T key when a desired filter level is displayed.

<i>Filter</i>	<i>Sensitivity</i>
Fil 10	Low
Fil 20	Medium
Fil 30	High
Fil 40	Severe



3. To disable filtering select “Fil Off” from the filter menu.

## Chapter 24: Date and Time

### Function Options:

Dat On	(dAt On)	Enables date and time printing with every weighing result.
Dat Off	(dAt OFF)	Disables date and time printing.
Dat Set	(dAtSEt)	Date configuration” allows to set the current date and time.
Dat Pin	(dAtPi n)	Enables PIN access to the Date Configuration.
Dat For	(dAtFor)	Format selection (United States / Europe).

### 24.1. Enabling and Disabling Date and Time stamping

1. Press the MENU key, when the option “Date” is displayed press the T key.



2. The scale will display options “Dat On, Dat Off, Dat Set, Dat Pin, Dat For” . To enable Date stamping press the T key when “Dat On” is displayed, to disable press the T key when “Dat Off” is displayed.

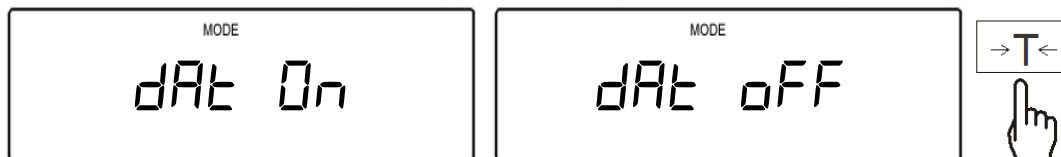

### 24.2. Setting the current date and time

1. Press the MENU key, when the option “Date” is displayed press the T key, and then select the option “Dat Set ” by press the T key once again.

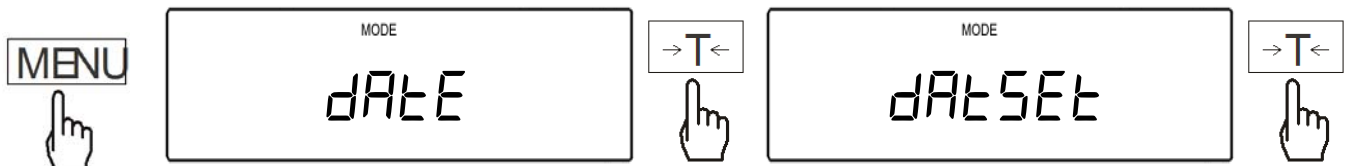

2. The current time will be displayed. To change or to set a new time press the T key

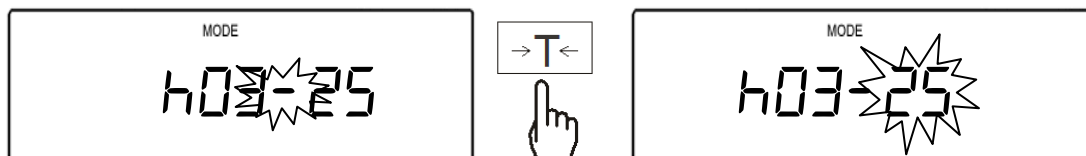



3. Use the following keys to change the current time

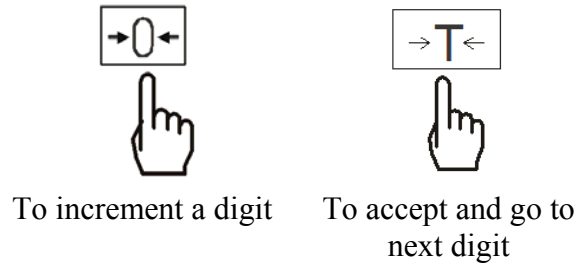

4. Once the time has been set the scale will display “PM” or “AM”. Press the T key when the desired setting is displayed.



5. Once the Time has been set, the scale will display the current date. To change or to set a new date press the T key

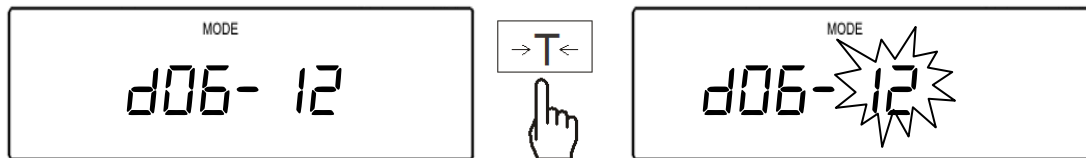

6. Use the following keys to change the date

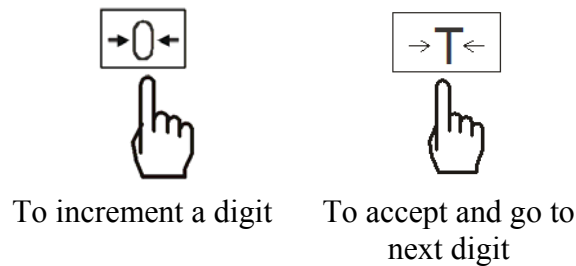

7. Once the time has been set the scale will display the current year. To change the years press the T key.

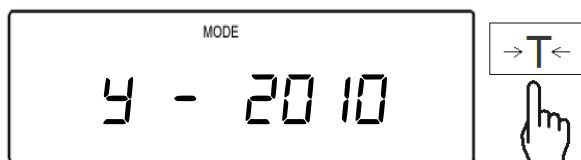

### 24.3. Enabling PIN access to the Date Configuration Function.

Configuration of the current date and time can be protected with a PIN. Once set the user is prompted to enter a pin number before time and date change is allowed.

1. To Set PIN for date configuration press the MENU key. When the option “Date” is displayed press the T key, and then select the option “Dat PIN ” by press the T key once again.

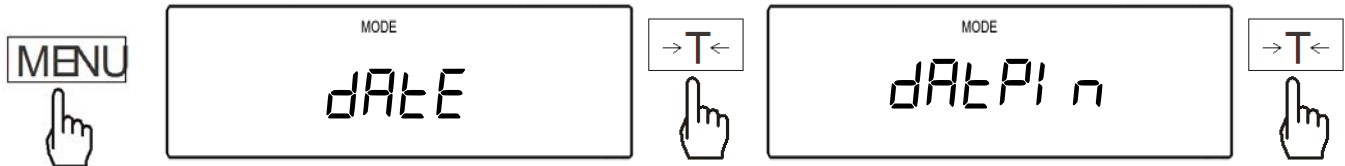

2. The scale will display a dashed line indicating to enter a desired PIN. To enter the PIN, use the following keys: the C key to increment a digit, the T key to accept and go to the next digit, the  key to insert a decimal, and the MENU key to accept the entire setting.

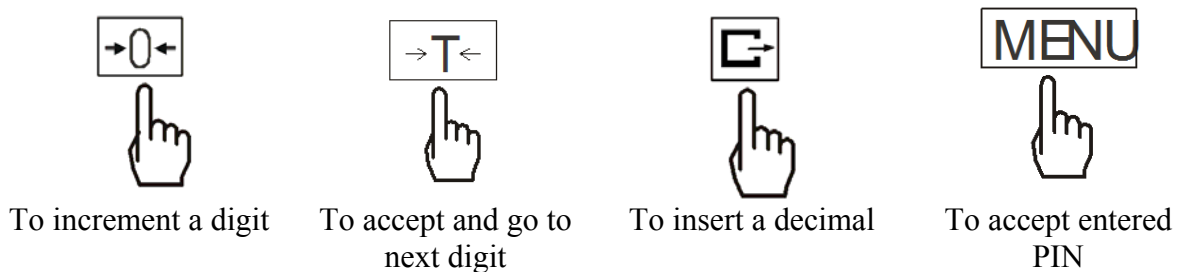

3. After setting the PIN, you will be asked to key in the pin in order to access the “Date and Time” feature. To remove or disable PIN access, enter the “Date” function and key-in the current PIN. After accessing the “Date” menu, select option “DatPin” and do not enter a new PIN number. Simply press the MENU key with the dashed line displayed.



## Chapter 25: Threshold Check Weighing (thr)

Threshold check weighing is used to check whether a weight of an object falls within specified threshold limits.

Function Options:

Thr Off	( <i>thrOFF</i> )	Disables threshold and check weighing.
Thr On	( <i>thr on</i> )	Enables threshold weighing and sets function parameters.
Thr Prn	( <i>thrPrn</i> )	Prints currently set parameters.
Dat Cfg	( <i>thrCFG</i> )	Sets output mode for the opto-isolator (Pulse Mode / Level Mode).

### 25.1. Enabling check weighing and setting threshold limits.

1. Press the MENU key, when the option “thr” is displayed press the T key, and then select the option “thr On” by press the T key once again.

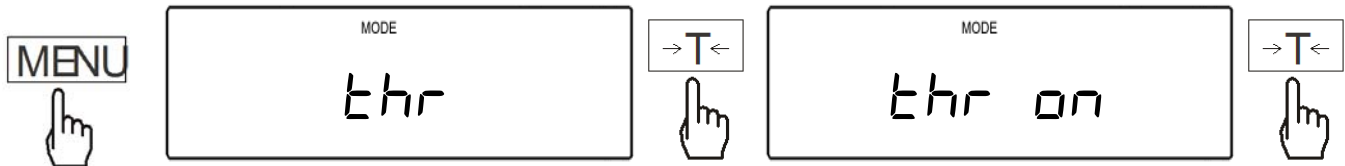

2. The scale will begin to display threshold limits. To set the Lower Limit waits for “Set-1” to display and press the T key. To set the Upper Limit waits for “Set-2” to display and press the T key. To set the minimum weight value that should be used in check weighing select “Set-3”.



3. The scale will display a dashed line indicating to enter the limit value. To enter the value, use the following keys: the C key to increment a digit, the T key to accept and go to the next digit, the  key to insert a decimal, and the MENU key to accept the entire setting.

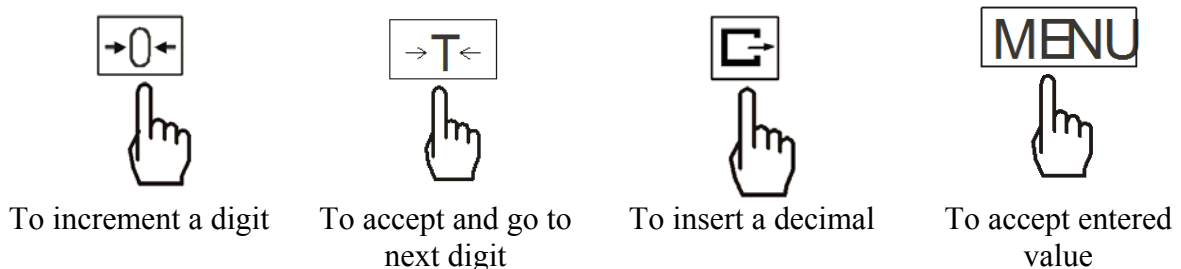

- After setting all limit sets, select “Set-0” in order to return to weighing with the limits enabled.

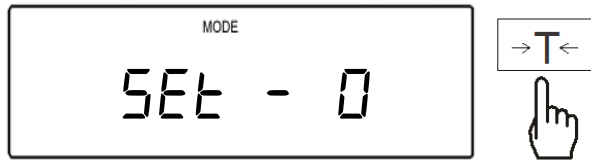

- To perform check weighing places the weigh on the Pan. The result is indicated by a dashed line located on the left side of the display.

LOW	OK	HIGH

- To disable check weighing enter the “thr” menu and select “thr Off”

- To view the threshold limits Press the Menu key, when the option “thr” is displayed press the T key, and then select the option “thrPrn ” by press the T key once again.

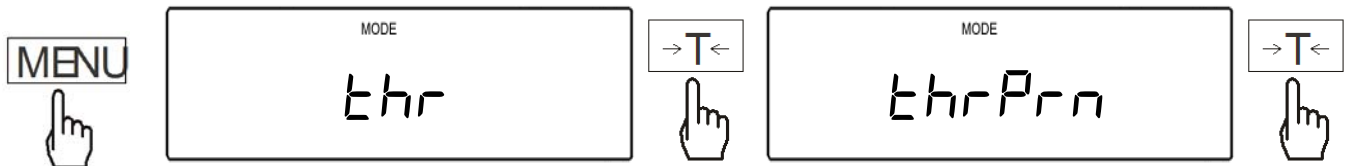

- Current limit sets will be displayed and transmitted via the RS-232 port. To view all limits use the T key.

LOW	HIGH	Min

## Chapter 26: Totalizing (tOtAL)

### Function Options:

Tot Prn (tOtPrn)	Displays and prints transaction total. (Does not reset the sum value)
Tot Off (tOtOFF)	Displays and disables the transaction total. (Resets the sum Value)
Tot o (tOt o)	Prints measurement weigh before adding.
Tot - (tOt -)	Adds measurement weigh to the total without printing

1. Place a container on the pan and press the T key to tare.

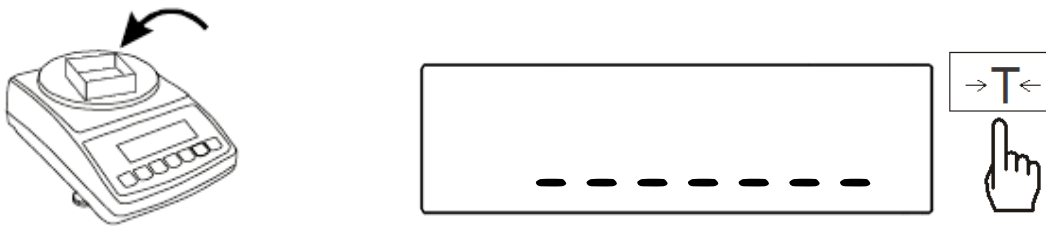

2. Press the MENU key, when the option “Total” is displayed press the T key, and then select the option “Tot o ” or “Tot –“ by press the T key once again.

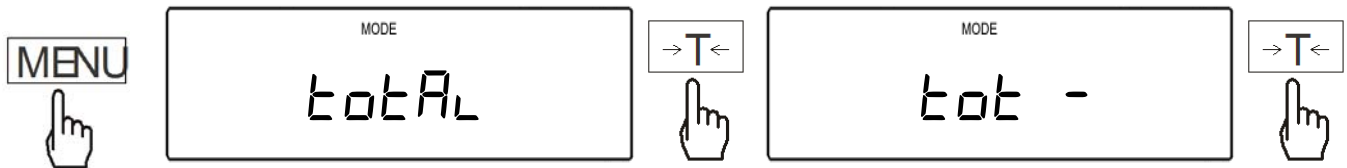

3. The display will read 0 indicating that you may place the first object into the container. Once the Weight of the object stabilized press the data transfer key  to accept and add the object weight to the total.

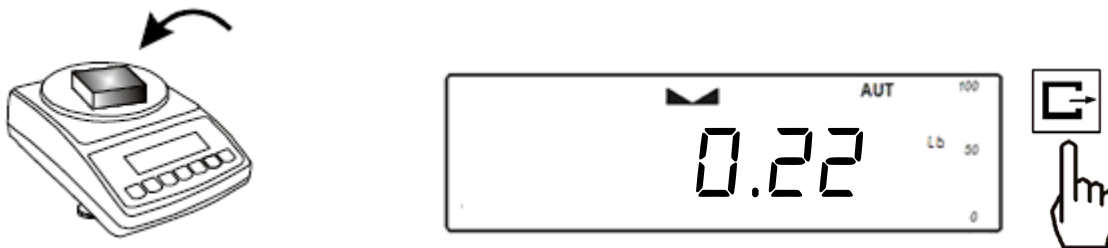

- Once the weight has been added, remove the object from the weighing pan.

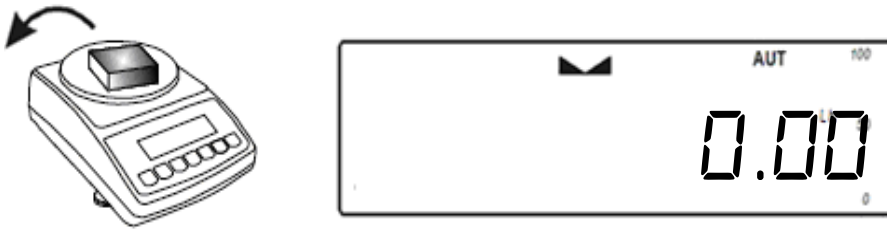

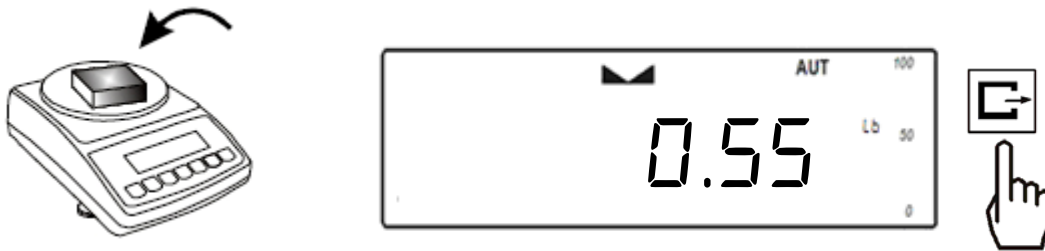

- Wait for the scale to return to 0 and place the second object on the pan. . Once the Weight of the object stabilized press the data transfer key  to accept and add the second object weight to the total.

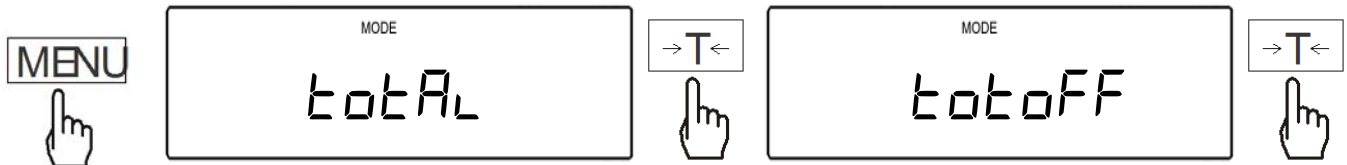

- Follow steps 3 through 6 until all object have been added. To view the total of the transaction press the Menu key, when the option “Total” is displayed press the T key, and then select the option “Tot Off” or “Tot Prn“ by press the T key once again.

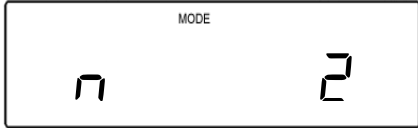

- The total will be displayed. To view the number of measurements added and the average press the Menu key.

Total	Number of measurements	Transaction Average
		

## Chapter 27: (bAttErY)

The battery function allows enabling or disabling charging of the internal rechargeable battery pack through the external power supply connected to the scale.



Never enable the “Batter” (bAttErY) function when operating the scale on conventional disposable AA Batteries. The “Battery” function may be enabled only when using rechargeable multi-use batteries.

### Warning !

**Enabling the “Battery” function and attempting to charge disposable, single-use, nonrechargeable AA batteries such as disposable carbon-zinc, alkaline or lithium cells, may be extremley hazardous. Batteries my overhet, spill, and/or explode.**

1. To disable or enable battery charging press the MENU key, when the option “Battery is displayed press the T key.

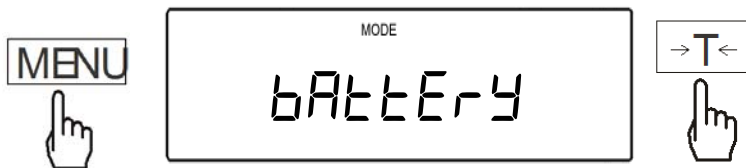

2. The scale will display options “BAT OFF”, “BAT ON”, “BAT VOL”. To disable battery charging press the T key “BAT OFF” is displayed, to enable battery charging press the T key when “BAT ON” is displayed.

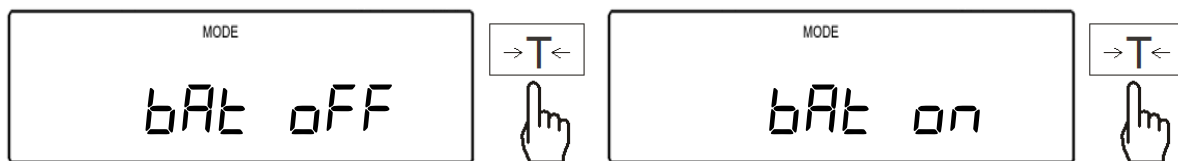

3. To check the batteries charging status press the T key when “BAT VOL” is displayed.



## Chapter 28: LCD Back Light (b\_LiGHt)

LCD Back Light (b\_light):

B\_L OFF (b\_L OFF) Disables LCD back light.

B\_L On (b\_L On) Enables LCD back light.

B\_L ECO (b\_L ECO) Disables the LCD back light after 30 second inactivity “no weight applied to the pan or the pressed keys.”

B\_L BAT (b\_L bAt) Disables back light only when operating the unit on batteries “no weight applied to the pan or the pressed keys.”

To configure or disable the LCD back light follow the steps below:

1. Press the MENU key, when the option “B\_Light” is displayed, press the T Key.

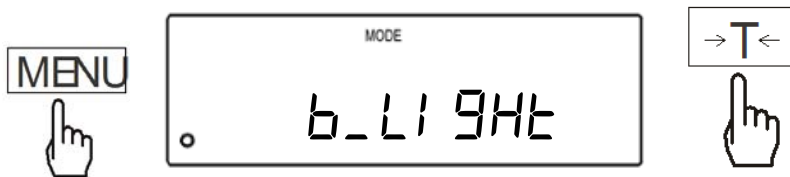

2. The scale will display available back light settings: “B\_L On”, B\_L Off, “B\_L ECO” and “B\_L BAT”.



3. To make a selection press the T key when desired back light setting is displayed.



## Chapter 29: Automatic Shutoff (AutoOFF)

Automatic shutoff (AutoOFF):

Aut OFF (Auto OFF)	Disables automatic shutoff – scale is always on.
Aut On (Auto On)	Enables automatic shutoff – scale turns automatically off after 5min of inactivity, “no weight applied to the pan or the pressed keys.”
Aut BAT (Auto BAT)	Enables automatic shutoff only when the unit is operating on batteries – scale turns automatically off after 5min of inactivity, “no weight applied to the pan or the pressed keys.”

To configure or disable the LCD back light follow the steps below:

- Press the MENU key, when the option “AutoOff” is displayed, press the T Key.



- The scale will display available auto shutoff settings: “Aut Off”, “Aut On, and “Aut\_BAT”.



- To make a selection press the T key when desired back light setting is displayed.

## Chapter 30: Menu Customization (ACTIU)

The Active function is used to customize the scale's Main Menu. This feature should be used to deactivate functions or features that are not used. Deactivated functions will not appear in the Main Menu which will simplify its use. To activate or deactivate features or function follow the steps below.

1. Press the MENU key, when the option "Active" is displayed press the T key, and then select a desired function or feature by press the T key once again when the name is displayed.

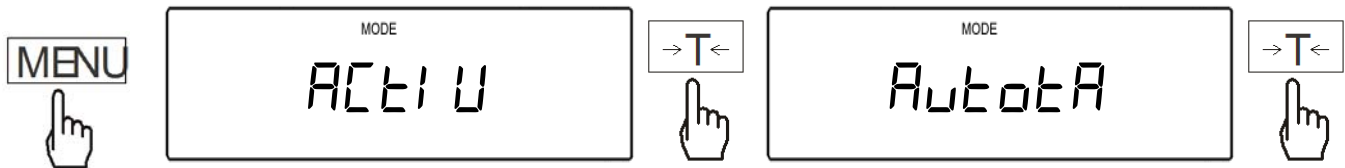

2. The scale will display options "ON" and "Off". To disable a function from appearing in the Main Menu press the T key when "Off" is displayed, to enable a function to have it appear in the Main Menu press the T key when "On" is displayed.



## Chapter 31: Resorting Default Settings (dEFAULT)

To restore the scale's factory settings follow the steps below

1. Press the MENU key, when the option "Default" is displayed press the T key.

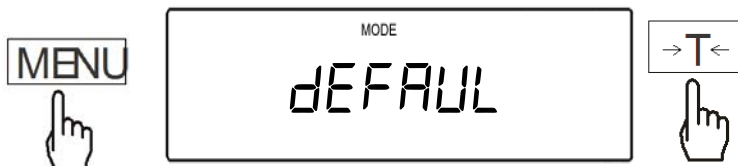

2. The scale will display options "Yes" and "No". To restore the scale's factory setting press the T key when "Yes" is displayed. To cancel press the T key when "No" is displayed.



## Chapter 32: Common Errors and Troubleshooting

Error or Indicator	Cause	Explanation / Solution
- - - -	Below zero	Re-zero the scale by pressing the →0← key.
- -	Taring is not allowed	Place a weight on the pan before taking a tare.
- -	Re-zeroing is not allowed	Remove weight from pan and clear stored tare values.
L	Pan error	Make sure that pan is properly seated on the pan support.
H	Exceeded capacity	The scale has exceeded its weighing capacity. Reduce the weight.
Err - b	Pan not cleared on power-up	The pan was not empty while the scale was initiating at startup. Clear the pan and restart the scale.
<i>Sapl LO</i> (Parts Counting)	Average piece weight is too low	The average piece weight is lower than 3e. Be sure that individual piece weight is greater than 3e.
<i>Sapl LO</i> (Percent Weighing)	Sample reference weight is too low	The sample reference weight is lower than 100d. Increase the sample weight.
The scale will not turn on	Possible power failure	Check the power AC adapter connection.
Weighing results are not accurate	Inaccurate calibration	Calibrate the scale.
Weighing result will not stabilize	Irregular environment	Eliminate drafts or vibrations.

## Chapter 33: Maintenance

### Cleaning and maintaining your Scale:

- Before cleaning the scale always unplug the A/C adapter from the electrical outlet.
- Use a soft, slightly damp cloth to clean the exterior housing of your scale,.
- Wipe the scale gently. Do not allow any liquid to enter into the scale.
- Do not apply extensive pressure to the LCD or the LED display.
- Do not use chemicals or benzene when cleaning the surface. Corrosive chemicals may damage the finish.
- Alcohol may be used only to clean the scale's stainless steel pan or the draft ring.

## Chapter 34: Limited Warranty

### PURCHASER'S 12-MONTH WARRANTY

Warranty is valid only if the attached warranty registration card is completed and returned within 30 days.

This product is a precision device made to exacting standards of scientific accuracy. It is guaranteed to have been adjusted and inspected for proper workmanship and performance, and certified for its currently advertised specifications before shipment.

Fulcrum Products are warranted against defects in material and workmanship under normal use and service. This warranty is extended only to the first purchaser. This limited warranty will not apply if, upon inspection, it is found that the product was tampered with, misused, overloaded, or abused, mishandled, placed in an improper environment, improperly installed or adjusted, used for a purpose other than that for which it was designed, or repaired by unauthorized personnel.

Fulcrum's liability under this warranty is limited to furnishing labor and parts necessary to remedy the defect covered by this warranty and restore the product to normal operating condition. Purchasers may be charged a minimum repair fee for in-warranty products returned for repair if those products are determined to be problem-free.

To make a claim under this limited warranty, obtain an RMA number from Fulcrum and return the product, carefully packed in its original packaging, shipping prepaid, with the RMA number written on the return package.